

Instructions for:

DIGITAL LIGHT

CLOSED LOOP COLOR DICHRO HEADS
DL1000, DL2500 & DL7000



JENSEN *Optical.*

615 South 1st AVENUE

Hillsboro, Oregon 97213

Phone 503 846 1492, Fax 503 640 1878

[www. DURST-PRO-USA.com](http://www.DURST-PRO-USA.com)

email: durst-pro-usa@msn.com

NOTES:

INTRODUCTION

Congratulations! You have purchased the state of the art in photographic enlargers. The DIGITAL LIGHT Color Dichro Head is designed to be a rugged machine, simple and elegant in design, yet sophisticated enough to facilitate high-volume, high-quality printing in today's professional photo lab.

The DIGITAL LIGHT Color Dichro Head can be used in virtually any photographic printing environment. The DIGITAL LIGHT uses printing values which are compatible with most video analyzers, and may be aligned to print perfectly with an analyzer's output color balance numbers. It also supports printing with variable-contrast black and white media.

All of these features are controlled using a single, easy-to-learn keypad, which is backlit for use in total darkness. There's no more reaching up in the dark to change a filtration setting. Operation of the DIGITAL LIGHT is just a matter of telling the machine what to do by pressing a few buttons.

The DIGITAL LIGHT CLOSED LOOP control system is based entirely on the Starlite 55 CPU developed by ZBE Inc. We proudly feature their innovations combined with the world famous Durst light mixing technology.

We at DURST-PRO-USA thank you for choosing the best in modern photographic light sources.

WHERE TO CALL FOR HELP and SUPPORT:

For any questions or problems regarding the DIGITAL LIGHT Color Dichro Head, please call or write our office at the address and phone number below:

**DURST-PRO-USA
615 South 1st AVENUE, HILLSBORO,
OREGON 97123, USA
Phone 503 846 1492,
Email: durst-pro-usa@msn.com**

If you are calling regarding a problem with the machine or with questions regarding operational procedures of the DIGITAL LIGHT, it is very helpful to have the phone available at the location of the machine. This will help speed the process of finding the problem or answering any questions.

DIGITAL LIGHT COLOR DICHRO HEAD MANUAL CONTENTS

INTRODUCTION.....	3
GENERAL SPECIFICATIONS.....	7
INSTALLATION.....	9
PLACEMENT CONSIDERATIONS.....	11
POWER CONSIDERATIONS.....	12
THE COMPUTER CONTROL SYSTEM.....	12
USING THE COMPUTER SYSTEM.....	12
GENERAL USAGE OF DEDICATED KEYS.....	14
KEYPAD.....	14
GENERAL USAGE OF MENUS.....	16
MENU FLOW CHART.....	17
FLOW OF FILTRATION OFFSETS.....	17
BASIC OPERATION.....	18
ENTERING A COLOR FILTRATION.....	19
ENTERING DENSITY.....	19
KEYPAD BACKLIGHT CONTROL.....	20
SAVING A JOB IN MEMORY.....	20
RECALLING A JOB FROM MEMORY.....	20
MAKING A SIMPLE EXPOSURE.....	20
SELECTING PREFERENCES.....	22
->1: SIZE TO DENSITY CORRECTION.....	22
->2: SHUTTER.....	22
->3: DENSITY SLOPE DIRECTION.....	22
->4: TIME TO DENSITY CORRECTION.....	22
->5: MAXIMUM LAMPS POWER.....	23
->6: AUTO LAMP SHUTOFF.....	23
->7: DISPLAY MODE.....	23
->8: PROBING LIGHT.....	23
->9: PROBE WITH AUTOCORRECTION.....	23
->10: LAMP POWER DISPLAY.....	24
->11: FILT. DENSITY CORRECTION.....	24
->12: ROLL EASEL SETTINGS.....	24
ADVANCED OPERATIONS.....	25

WORKING WITH A STANDARD COLOR BALANCE WITHOUT A VIDEO ANALYZER.....	25
HOW TO MAKE A PRINT BY TESTING (NO VIDEO ANALYZER).....	28
WORKING WITH A VIDEO ANALYZER (DAILY SHIRLEYS)	30
MAKING A PRINT USING A VIDEO ANALYZER	33
BLACK AND WHITE PRINT MODE.....	35
HOW TO MAKE A BLACK AND WHITE PRINT BY TESTING.....	36
NOTES ON BLACK AND WHITE MODE.....	37
SETTING UP PAPER STOCK EMULSIONS	38
SETTING AND MAINTAINING PROCESS OFFSETS.....	41
KEYPAD OVERVIEW.....	43
MAIN MENU OVERVIEW	46
->1: RELOAD PRINT COUNTER.....	46
->2 : EMULSION	46
->3 : SELECT LENS	47
->4 : PROCESS	47
->5 : PREFERENCES.....	47
->6 : CALIBRATION.....	47
->7 : MAINTENANCE.....	47
->8 : DIAGNOSTICS	48
->9 : DODGE & BURN BEEPS.....	48
->10: PRINT MODE	48
PREFERENCES MENU	49
->1 : SIZE TO DENSITY CORRECTION.....	49
->2 : SHUTTER	49
->3 : DENSITY SLOPE DIRECTION	50
->4 : TIME TO DENSITY CORRECTION	50
->5 : MAXIMUM LAMPS POWER	50
->6 : AUTO LAMP SHUT OFF	50
->7 :DISPLAY MODE	51
->8 : PROBING LIGHT	51
->9 : PROBE WITH AUTOCORRECTION	51
->10: LAMP POWER DISPLAY	51
->11: FILT. DENSITY CORRECTION.....	51
->12: ROLL EASEL SETTINGS	52
ROLL EASEL SETTINGS MENU	53
->1: ROLL EASEL INPUT	53
->2 : ROLL EASEL OUTPUTS	53
->3 : ROLL EASEL TIMING.....	54
ROLL EASEL INPUT MENU.....	54
->1: START EXPOSE ON SWITCH CLOSED.....	55
->2: START EXPOSE ON SWITCH OPEN.....	55
->3: LAMP ON WITH SWITCH CLOSED.....	55
->4: LAMP ON WITH SWITCH OPEN	55
->5: SYSTEM HOLD WITH SWITCH CLOSED.....	56

->6: SYSTEM HOLD WITH SWITCH OPEN	56
->7: AUTO RESTART EXPOSE (NO INPUT)	56
ROLL EASEL OUTPUTS MENU	57
->1: START EXPOSE RELAY CLOSED	58
->2: START EXPOSE RELAY OPEN	58
->3: END EXPOSE RELAY CLOSED	58
->4: END EXPOSE RELAY OPEN.....	58
->5: EXT SHUT RELAY CLOSED.....	58
->6: EXT SHUT RELAY OPEN.....	58
->7: EXT SHUT RELAY CLOSE EXPOSE	59
->8: EXT SHUT RELAY OPEN EXPOSE.....	59
->9: LAMP BLOWN RELAY CLOSED	59
->10:LAMP ERROR RELAY CLOSED	59
->11:PLATEN CONTROL RELAY CLOSED.....	59
ROLL EASEL TIMING MENU.....	60
->1: START PULSE TIME.....	60
->2: END PULSE TIME	60
->3: END DELAY TIME	61
->4: ERROR PULSE TIME	61
->5: PAPER ADVANCE TIME.....	61
->6: EXT SHUT LAMP DELAY	61
CALIBRATION MENU	62
->1: EDIT PROCESS OFFSETS.....	62
->2: CALIBRATE MASTER COLOR BALANCE.....	62
->3: EDIT MASTER COLOR BALANCE OFFSETS	63
->4: EMULSIONS.....	64
->5: EDIT LENS OFFSETS.....	64
->6: CALIBRATE B&W PROBE DENSITY.....	64
->7: INSTALLING A NEW MIXING BOX.....	64
->9: EDIT VC-SCAN CHANNELS.....	65
->10: EDIT COLOR PRO STYLES.....	65
->11: EDIT COLOR PRO FILMS	65
->12: EDIT COLOR PRO CALIBRATION VALUES	66
->13: FILT DENSITY CORRECTION GAINS	66
MAINTENANCE MENU	67
->1: UNDO LAST PROBING.....	67
->2: ERASE ONE JOB.....	67
->3: ERASE ALL JOBS.....	67
->4: ERASE ALL EMULSIONS	67
->5: ERASE VC-SCAN CHANNELS	67
->6: ERASE COLORPRO STYLE & FILMS	68
->7: MASTER RESET	68
DIAGNOSTICS MENU.....	69

->1: MANUAL CONTROL TEST.....	69
->2: COLOR DICHRO HEAD CYCLE MODE.....	70
->3: PROBE TEST.....	70
->4: RMS VOLTAGE TEST.....	70
->5: ROLL EASEL TEST.....	71
->6: CONTINUOUS READOUT.....	71
->7: AUTO CALIBRATE SENSOR.....	71
->8: STACK CHECK.....	71
->9: MIXING CHAMBER DETECTORS TEST.....	71
->10: VC-SCAN TEST.....	72
->11: COLOR-PRO TEST.....	72
->12: ADC TEST 0-7.....	72
->13: ADC TEST 8-15.....	72
->14: RESET-CYCLE COUNTERS.....	72
->15: CYCLE-MOTORS.....	72
RMS LAMP POWER COLOR ERROR CORRECTION.....	73
SYSTEM OVERVIEW.....	74
PROGRAMMING.....	74
MAKING THE PRINT.....	75
READING PRINTS AND PROGRAMMING POINTS.....	76
MORE INFORMATION.....	77
MECHANICAL MAINTENANCE & UPGRADING.....	79
GENERAL CLEANING INFORMATION.....	79
FILTER TRANSPORT.....	79
LAMPS.....	79
MIXING CHAMBER.....	80
UPGRADING.....	
DIGITAL LIGHT ACCESSORIES.....	81
DIGITAL LIGHT SERIAL COMMUNICATIONS COMMANDS FOR RS-232 INTERFACES.....	81

GENERAL SPECIFICATIONS

The DIGITAL LIGHT Color Dichro Head is designed to be a high-volume, high-speed Color Dichro Head for custom color and BW printing. This, as well as the other items listed below, should be considered when installing the DIGITAL LIGHT on any particular enlarger chassis.

DIGITAL LIGHT COLOR DICHRO HEAD SPECIFICATIONS:

Power Requirements:	DL1000 units:	15Amp 115-120 Volt, 50-60HZ Including Condenser Color Dichro.
	DL1500HI:	15Amp 115-120 Volt, 50-60HZ
	DL2000 units:	15Amp, 240 Volt, 50-60HZ
	DL7000 units:	35Amp, 240 volt, 50-60HZ
Lamp Requirements:	DL1000 units:	Three DULAMP 450-S
	DL1500HI:	One DULAMP 1200-TOP
	DL2000 units:	Six DULAMP 450-S
	DL7000 units:	Seventeen DULAMP 450-S
Lamp Control:		Internal electronic voltage stabilizer
Filtration Type:		Subtractive filtration using glass Dichro Filters
Filtration Calibration:		Standard color-correction (CC) units (30 CC's = 1 f-stop)
Filtration Range:		0 - 180 CC's on any color channel plus 5 f-stops of neutral-density range
Exposure Time Range:		1 second to 999.9 seconds, in increments of 0.1 second
Shutter:		Rotary shutter for exposure time control
Size of Light Output Area (Diffuser):		5x7" through 12x16"
Minimum Clearance Around Head:	Front:	3" for vent
	Top:	4" for vent

NOTE: The DIGITAL LIGHT will tend to heat a small, closed room to uncomfortable temperatures with prolonged use, so adequate ventilation is suggested for operation.

INSTALLATION

The DIGITAL LIGHT Color Dichro Head is designed to be used on any photographic enlarger, printer, duplicating camera, etc., and as such, there is no single procedure for the installation of the Color Dichro Head.

However – when you turn your DIGITAL LIGHT Color Dichro Head on for the first time – please allow the electronics 90-120 seconds to go through a setup phase where it calibrates its mixing box to your existing conditions.

The DIGITAL LIGHT CLOSED LOOP COLOR Dichro Heads are manufactured specially for Durst 8x10” / 10x10” chassis both vertical and Horizontal.

Mounting adapters for several popular enlargers are available from DURST-PRO-USA

These enlargers include:

De Vere
HK
Salzmann

Contact DURST-PRO-USA at the number and address shown on page 3, for information on these adapters and specific installation procedures.

PLACEMENT CONSIDERATIONS

When mounting the DIGITAL LIGHT Color Dichro Head on an enlarger. There are several considerations concerning physical placement and power consumption.

Access

The DIGITAL LIGHT Color Dichro Head should be installed so nothing will hit or rub against the AC power cord, or keypad coiled cord, during normal operation.

Cooling

The DIGITAL LIGHT Color Dichro Head DL1000 and DL1500HI has its own internal cooling fan for its lamps. The DL2000 and DL7000 unit has an external cooling system. The cooling system is designed for maximum efficiency, allowing one fan to cool the lamps, with two light-tight vents on the exterior of the cabinet. The air intake vent is located on the side of the head, while the exhaust vent is located on the top of the head. Both of these vents should be completely free of obstructions when the head is in its operating position. The head should be mounted such that any flat surfaces are at least four inches (4") from these vents.

Orientation

The DIGITAL LIGHT Color Dichro Head is designed to operate in any position, including upside-down. The DL7000 can only be operated in the vertical position. When the exhaust vent in the top of the head is pointing down (that is, the head mounted upside-down), it is a good idea to keep surfaces at least five to six inches from the vent.

POWER CONSIDERATIONS

The DIGITAL LIGHT **DL1000** uses three 410watt lamps for its light. This means that the head will draw over 10 amps of current when the lamps are at full power. The power availability of the AC mains circuit into which the DIGITAL LIGHT is connected should be able to comfortably handle this amount of power, without dropping in voltage. The minimum requirement for the electrical line is a 110v, 15-Amp circuit.

The DIGITAL LIGHT **DL1500HI** is using ONE 1200watt lamp for its light. This means that the head will draw over 10 amps of current when the lamps are at full power. The power availability of the AC mains circuit into which the DIGITAL LIGHT is connected should be able to comfortably handle this amount of power, without dropping in voltage. The minimum requirement for the electrical line is a 110v, 15-Amp circuit.

The DIGITAL LIGHT **DL2000** uses six 410 w lamps for its light. This means that the head will draw more than 32 amps of current when the lamps are at full power. However the actual Amperage is 10 at 240Volts. This is obtained by using a power transformer. The power availability of the AC mains circuit into which the DIGITAL LIGHT is connected should be able to comfortably handle this amount of power, without dropping in voltage. The minimum requirement for the electrical line is a 240v, 15-amp circuit.

The DIGITAL LIGHT **DL7000** uses seventeen 410 w lamps for its light. This means that the head will draw over **90 amps** of current when the lamps are at full power. However the actual Amperage is 30 at 240Volts. This is obtained by using a power transformer. The power availability of the AC mains circuit into which the DIGITAL LIGHT is connected should be able to comfortably handle this amount of power, without dropping in voltage. The minimum requirement for the electrical line is a 240v, 30-amp circuit however we do recommend a 240v, 40-amp circuit.

The condition of the line voltage is also important. Although the DIGITAL LIGHT has internal voltage stabilization for its lamps, voltage fluctuations on heavily-loaded lines may be too large or fast for the stabilizer to compensate. Power circuits with high-power machinery, particularly photo processors, should be avoided. A dedicated line is ideal for the DIGITAL LIGHT and other sensitive darkroom equipment.

THE COMPUTER CONTROL SYSTEM

The DIGITAL LIGHT is a computer-controlled photographic light source, with many features that will simplify day-to-day printing. It is a good idea to understand the nature of the control system to get the most from your new Color Dichro Head. This section offers a simple description of this system.

The Color Dichro Head controller allows the DIGITAL LIGHT to be one of the most productive Color Dichro Heads on the market, maintaining constant filtration and density, exposure times and counts, and compensation for different paper types, along with many other features. All this is controlled by an easy-to-learn keypad, which is fully backlit for use in the dark.







USING THE DIGITAL LIGHT COMPUTER SYSTEM

The keypad which controls the Color Dichro Head features a number of keys dedicated to operations frequently used in routing printing. These include keys for setting color filtration, print density and exposure time, and of course, starting exposures. This makes most operations with the Color Dichro Head a simple matter of a few keystrokes.





There are many more features built into the DIGITAL LIGHT Color Dichro Head. However, if each and every feature had a button of its own, the keyboard would become too large and complicated to use conveniently, especially in the dark. To make things easier, these features are accessed through a menu-driven software system.

Reading this section will help you become familiar to how the DIGITAL LIGHT control system is operated.

GENERAL USAGE OF DEDICATED KEYS

The operation of the DIGITAL LIGHT's keypad is simple. To change any value accessed by one of the dedicated keys ( ,  ,  ,  ,  ,  , etc.), simply press the appropriate key, enter the desired numeric value, then press .

For example, say you want to change the exposure time to 12.5 seconds:

1. First, press . A cursor will blink next to the time displayed on the keypad.
2. Type the number of seconds, then tenths of seconds. For 12.5 seconds, type  ,  ,  . The decimal point always stays in one place.
3. When finished, press . The new value is now entered in the computer.

All number entry in the computer system is done in a similar manner. If a value has a decimal point in it, the decimal will be fixed at a given number of places for that particular value. Entering zeros will move the number to the desired position if no fractional value is needed.

If, during the entry of a number, you enter an incorrect value and want to change it, entering a few zeros will cause the number to blank back to zero, allowing a new entry.

DIGITAL LIGHT KEYPAD

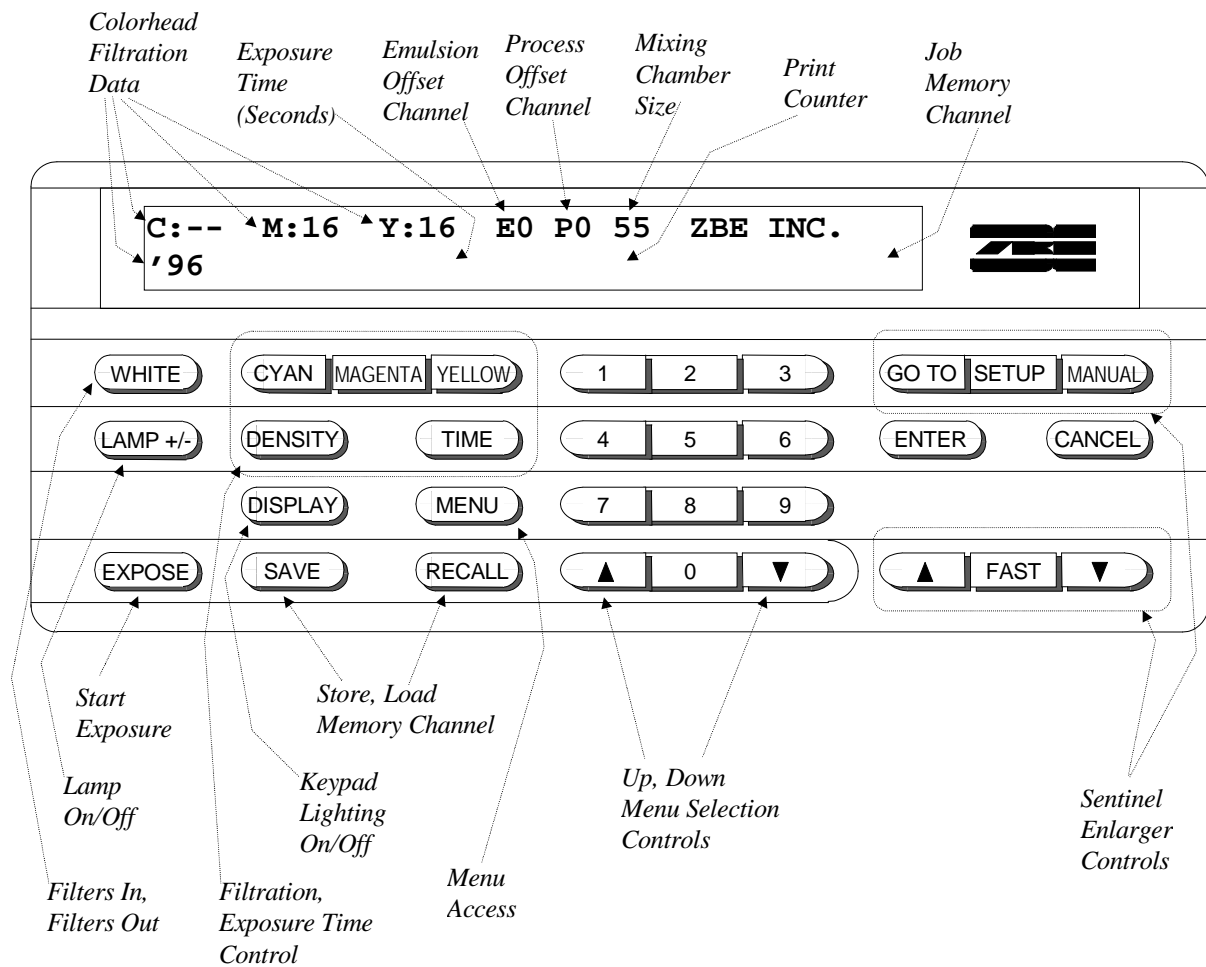



GENERAL USAGE OF MENUS



The menu system is organized into sections, called sub-menus. Each sub-menu, accessed through the main menu, contains a group of items which are related to one-another. For instance, all of the functions needed to initially set up the DIGITAL LIGHT Color Dichro Head for daily operation are grouped in a sub-menu called “CALIBRATION.” This sub-menu appears as one of the items in the MAIN menu.

Finding the item you want in the menu system is quite simple. The keys involved are listed below and the function of each is explained as it pertains to the menu system.

 : Puts the user in the main menu, from which all other menus are accessed. When in a menu list, pressing this key will advance the current selection to the next item.

 : Select the previous item in the current menu list.

 : Select the next item in the current menu list. This is the same as pressing the  while in a menu.

 –  : All of the items in each menu are numbered. Pressing a number key will move the current selection to the item with that number. For experienced users, this is a faster way to get the desired item.

 : Activates the menu item currently selected. If that item is a sub-menu (such as “CALIBRATION”), that menu will now be displayed.

 : Exits the menu system and returns to the main screen display.

The current selection is always displayed on the top line of the display, with a “->” prompt next to it. The next available selection is shown on the bottom line. In the text of this manual, the word “select” means to position the -> prompt next to a menu item. The words “go into” mean to access that indicated item by positioning the -> prompt next to it and then pressing .

Understanding the menu system will make using the machine easier and more productive. It is worth a minute to run through the menus and familiarize yourself with how they work and what they offer.

DIGITAL LIGHT MENU FLOW CHART:

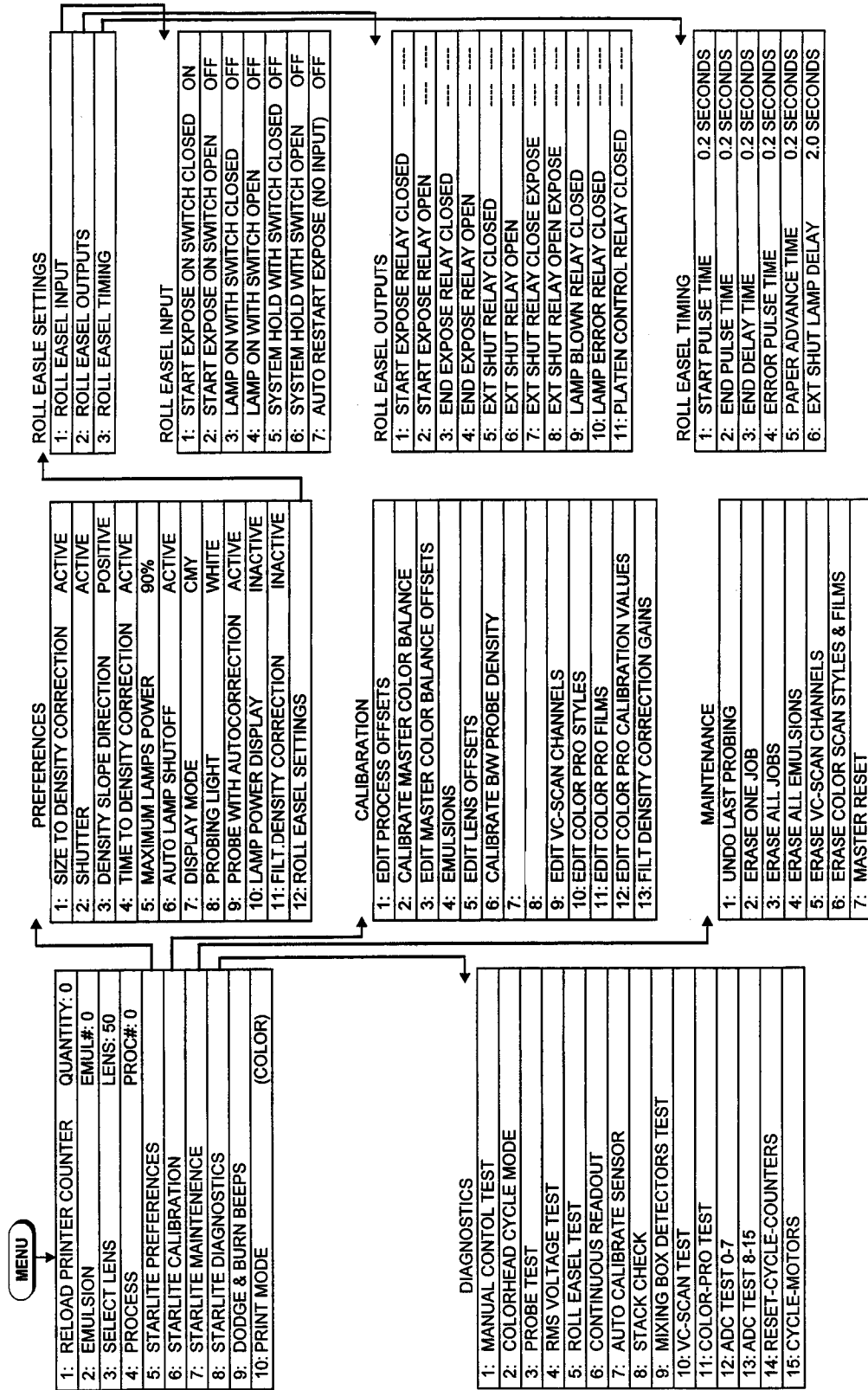

FLOW OF FILTRATION OFFSETS

The DIGITAL LIGHT Color Dichro Head features several different types of filtration and density offsets to make operation easier. To fully gain the benefit of these offsets, it helps to know how each type affects that light output of the Color Dichro Head. Below is a chart depicting all of the different offsets and how they are added up to get from the filter pack numbers entered at the keypad to the actually light emitted from the head.

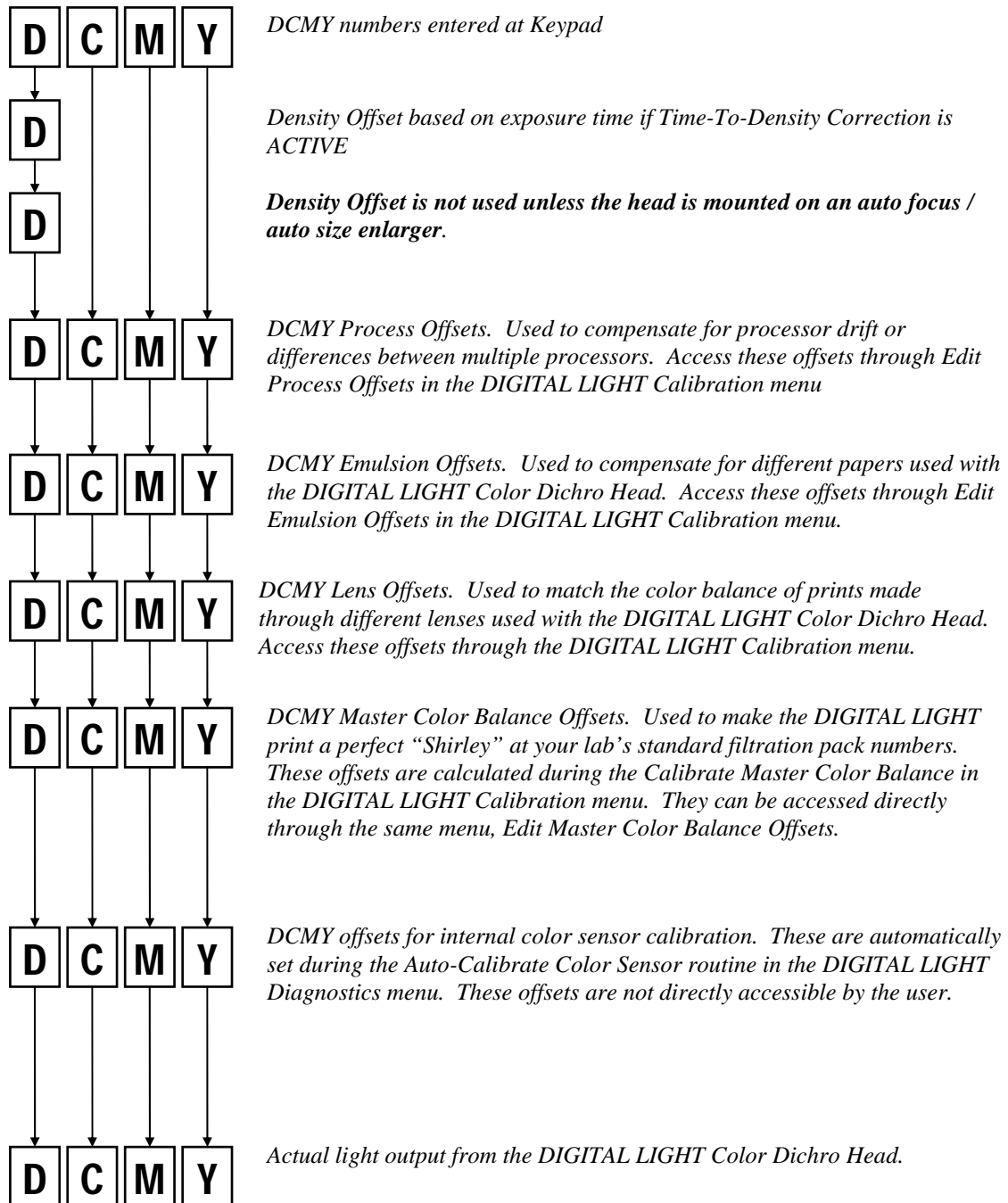

BASIC OPERATION

This section covers topics necessary for the basic operation of the DIGITAL LIGHT Color Dichro Head.

Such topics as focus lamp control and entering color filtration and density settings are covered here with a view towards the first-time user. In this section, we assume that the DIGITAL LIGHT is already mechanically installed on the machine on which it is to be used.

TURNING THE POWER ON

The main power for the DIGITAL LIGHT is controlled by a single switch.

When power is turned on, the DIGITAL LIGHT will go through its calibration procedure. During this procedure, which takes about twenty seconds, the display on the keypad will show an opening message. This auto-calibration process assures that the DIGITAL LIGHT will print the same day after day, lamp after lamp.

LAMP ON/OFF CONTROL

The lamp may be turned **on** or **off** using **LAMP +/-**. When the lamp is turned **on**, the bulbs will light and the shutter will open. If in Filtered Light mode, the light output will change to the color settings specified in the upper left area of the keypad display. If the Color Dichro Head is in White Light mode, the output will change to a bright white light used for focusing or composing a print.

To toggle between Filtered Light mode (for printing) and White Light mode (for focusing), use **WHITE**. If this key is pressed while in Filtration mode, the White Light mode will be selected. At this time, the lamp will turn **on**, and the output will change to white light. The lamp will now stay **on** until **WHITE** or **LAMP +/-** is pressed. If **WHITE** is pressed, the head will return to Filtration mode; the light output will return to the specified color, then the lamp will extinguish, and it will be ready for printing. If **LAMP +/-** is used, the lamp will simply turn **off** and the head will remain in White Light mode, with the upper left area of the keypad display reading "FILTERS OUT."

NOTE: In Filtered Light mode, there may be a delay between the time when **LAMP +/-** is pressed and when the lamps actually go out. This is due to the head making fine adjustments to the color output. This delay, which is usually several seconds, is normal.

ENTERING A COLOR FILTRATION

To enter color filtration setting in the DIGITAL LIGHT Color Dichro Head, the following keys are used:

- CYAN**, **MAGENTA**, **YELLOW** Press one of these color keys to get a prompt for the particular filtration value you wish to change. These keys can be used to jump between different color values when entering more than one.
- 1** – **9** The number keys are used to type in a numeric value for the filtration.
- ENTER** After typing the new value for a color, press this key to lock in the new setting.
- LAMP +/-** Used to toggle the number being entered between a positive and negative value.
- EXPOSE** While entering a value, this key is used to make your entry an *incremental* change in the current value. Use this key to enter filtration *changes* rather than specific values.
- CANCEL** Used to abort the entry of the value currently being entered. The old value will then be restored.

Example #1- To enter a Magenta value of 30cc:

1. Press **MAGENTA**. The cursor will appear at the current Magenta (“M:”) value on the keypad screen.
2. Type **3**, **0**. The digits will appear as they are typed in.
3. Press **ENTER**. The DIGITAL LIGHT lamp will now turn on while the new amount of magenta is locked in.

Example #2- To change the Magenta value by -7cc:

1. Press **MAGENTA**. The cursor will appear at the current Magenta value (“M:”) on the keypad screen.
2. Press **EXPOSE**. The screen will show the word “INCREMENTAL” on the lower line.
3. Type in the amount of change you want. For this example, type **7**.
4. Press **LAMP +/-** once to make this value negative (“-7”).
5. Press **ENTER**. The value you entered will now be added to the current magenta value, and the lamps will turn on to lock in the new filtration

ENTERING DENSITY

The DIGITAL LIGHT Color Dichro Head features neutral density control, which allows it to control the intensity of its light output internally, instead of having to adjust lens aperture. The density value is printed out in the main display, below the color filtration.

The density value, like the color filtration values, is in standard color correction units (CC's), with 30 points = one f-stop. The entering of a density value is similar to color entry: press

DENSITY, type the numeric value, then press **ENTER**. **▲** and **▼** in the numeric pad may also be used to increase or decrease the density by one CC.

When a density value is entered, the Color Dichro Head's lamps will turn **on**, and the intensity of the output will be changed to the new density. If the new density value is too bright or dim for the capability of the DIGITAL LIGHT, the exposure time will be adjusted to compensate for the amount of light change not possible with light power alone.

KEYPAD BACKLIGHT CONTROL

The keypad is fully backlit for use in the dark. However, during the handling of photographic paper and while printing, the light from the keypad may not be desired. To extinguish the keypad's lighting, just press **DISPLAY**. This will toggle the backlights off and on.

In addition to the on/off control, the intensity of the backlighting may be adjusted. A small knob is provided under the right end of the keypad unit for this purpose.

SAVING A JOB IN MEMORY

The DIGITAL LIGHT has about 250 job memory channels that can be used to store specific print jobs. The information stored for each job is the following: D, C, M, and Y, exposure time, emulsion number, and f-stop. The f-stop is used only for the operator's reference and is not used by the computer in any calculations. To save a job press **SAVE**. You will be prompted for a job number; enter a five digit number of your choice. If that number is already in use you will be asked if you would like to over-write the old job information. Next you will be prompted for an f-stop value. The value you enter here will be displayed when that job is recalled.

While doing test prints, it is a good habit to save the job after each exposure to ensure that the latest data is always saved.

RECALLING A JOB FROM MEMORY

To recall or load a job that was previously saved press **RECALL**. You will be prompted to enter a job number. If the computer cannot find a job by the number entered, the display will show "DOESN'T EXIST, TRY AGAIN." When the job is recalled the light will turn on and the filtration will be put in, and the recalled f-stop is displayed for a few seconds. The display will then go back to the main screen and the light will turn off. The enlarger is now ready for printing.

MAKING A SIMPLE EXPOSURE







Making a test exposure with the DIGITAL LIGHT is similar to other Color Dichro Heads. The DIGITAL LIGHT has the ability to remember print setups, so that once a test print is successful, it need not be done again. A procedure for making a test print is outlined here:

1. Load your negative in preparation for printing.
2. Turn the lamps **on** by pressing **WHITE**. The keypad display should read “FILTERS OUT” and the lamps will come **on**. (If not, press **WHITE** again.) Compose and focus the image as desired.
3. Enter the desired first-time print data for Cyan (usually zero), Magenta, Yellow, and Density. Entering filtration data while in White Light mode will cause the head to revert back to Filtered Light output.
4. Enter the desired exposure time.
5. Just before making the actual print, save the setup under a job number in the memory. This way the setup will be saved if the machine is used while this test print is in process (perhaps for another test exposure).
6. Place the paper in position and make the print by pressing **EXPOSE**. Before handling paper, you can press **DISPLAY** to extinguish the keypad lights.

This is one round of the test printing process. Several tests may be required to achieve a perfect print. Once the perfect print is made, this final setup should be saved so that it may be recalled from memory if reprints of the negative are required in the future.

SELECTING PREFERENCES

The Preferences menu lets you adjust and select many aspects of the Color Dichro Head's operation. The actual operation of this menu is different than that of the other menus in the system.

Each item in the Preferences menu, when selected will enable you to enter new data or change a setting right there in the menu list itself. Each item's current setting will appear to the right of its name in the menu list. As you scroll through the list using  and , you can examine all the current settings just by reading them along the right-hand side of the keypad screen. To change an item, simply press , and a cursor will appear next to the setting. Generally, you can press  or  here to change the setting to any one of its possible values, or, if that setting is a numeric value, type in the new value. Once the new setting is correct, press  again. This will return you to the left side of the screen, and you will then be able to continue to scroll through the Preferences menu. This operation will continue until you press  to get back to the main screen.

The items in the Preferences menu are listed as they appear on the keypad and described below. The settings shown are the factory defaults.

->1: SIZE TO DENSITY CORRECTION ACTIVE

The head adjusts lamps automatically after sizing change. Available only with auto focus / auto size enlargers.

->2: SHUTTER ACTIVE

Disables or enables internal shutter. If using the DIGITAL LIGHT on an enlarger, you should leave this setting on "ACTIVE". If the DIGITAL LIGHT is to be used as the lightsource for a photo printer or on a similar machine that has its own shutter, you can make the Shutter "INACTIVE".

->3: DENSITY SLOPE DIRECTION POSITIVE

Sets whether an *increase* in the density value means *more* light ("POSITIVE") or *less* light ("NEGATIVE"). Most video analyzers use a positive density slope.

->4: TIME TO DENSITY CORRECTION ACTIVE

Links the density value on the main screen readout to the exposure time. If this preference is “ACTIVE”, whenever you change the exposure time in the main screen by pressing , the density value will change to reflect what density change will occur at the print, due to your time change. This effectively makes the DIGITAL LIGHT main screen density value represent the *print density* rather than just the light density coming from the DIGITAL LIGHT.

->5: MAXIMUM LAMPS POWER 90 %

Sets maximum allowed lamp power. This figure can range from 60% to 99%. The higher the value, the more light you will be able to get from the DIGITAL LIGHT. The lower the value, the longer your lamps will last. This setting only limits the *maximum* lamp power – it does not lock the lamp power to a specific setting.

->6: AUTO LAMP SHUTOFF ACTIVE

If Active, lamps always switch **off** after 5 minutes of idle time. This setting is sometimes set to “INACTIVE” if the DIGITAL LIGHT is used as a light source for a slide-duplicating machine or any application where the lightsource must remain on for long periods of time.

->7: DISPLAY MODE CMY

Sets color display mode to CMY or RGB. This preference only affects the color names that are displayed. The actual operation of the DIGITAL LIGHT remains the same.

->8: PROBING LIGHT WHITE

Sets filtered or white light during probing. When the Density Probe is activated, the light that is used to read the current baseboard density can be set to “WHITE” for probing neutral density, or “FILTERED”, for probing visual density. If using the DIGITAL LIGHT in conjunction with a video analyzer, you will usually leave this setting at “WHITE.”

->9: PROBE WITH AUTOCORRECTION ACTIVE

Selects whether or not the light output of the DIGITAL LIGHT will be adjusted by the computer when the Density Probe is activated. If this setting is “ACTIVE” when the D-Probe button is pressed, the head will adjust it’s light output so that the probe reads the proper amount of light at the baseboard for the current main-screen density value. If “INACTIVE”, the D-Probe simply displays a probe density value, letting you adjust the baseboard light level

ADVANCED OPERATIONS

WORKING WITH A STANDARD COLOR BALANCE WITHOUT A VIDEO ANALYZER

(“Shirley” is the industry name for a standard test negative – obtainable from several outlets. You can also produce your own “Shirley”. We normally recommend that you produce your own standard, particular if you are working in BW, contact Jens J Jensen for a detailed explanation of how to make a standard test negative.)

Summary:

1. Setup your enlarger for printing your Shirley negative.
2. Enter an exposure time using **TIME** (5 seconds).
3. Select Emulsion channel 0 (zero) from the main menu.
4. Enter a filtration of C0 M40 Y40.
5. Enter a Density of 0.
6. Use the most popular paper stock: this paper will be represented by Emulsion channel 0.
7. Press **EXPOSE** to make exposure.
8. Adjust Magenta, Yellow and Density to achieve a perfect print.
9. Make test prints until you have a perfect print.
10. Go into Calibration menu.
11. Select Calibrate Master Color Balance from menu.
12. Enter the video values for D,C,M, and Y. (64 0 30 30)
13. Press **ENTER** when asked to calibrate Density Probe.
14. Place empty carrier in enlarger, turn off room lights.
15. Place probe directly under lens on baseboard. Wait 6 seconds.
16. Press **ENTER** to take probe reading.

Your DIGITAL LIGHT can be aligned so your standard setup negative prints perfectly at any set of DCMY values you choose to use. In other words, the filtration at which your Shirley prints perfectly may be given any set of D,C,M, and Y color correction values, according to your personal choice or your lab’s standard. Many labs like their setup negative to print at D64 C0 M30 Y30, another popular setting is D64 C0 M16 Y16. You may find it more convenient to use a round number for the Density such as 0 or 100; it’s your choice.

1. Setup your enlarger for printing a Shirley negative. Use your normal lens, carrier, easel, etc.
2. Enter an exposure time, say 5 seconds. Exposure time is entered by pressing **TIME**.

3. Select Emulsion 0 (zero) in the main menu. This channel will represent the type of photo paper on which you are about to test-print your Shirley.
4. Enter a filtration pack to start with. A setting of C:0 M:40 Y:40 is a good starting place.
5. Enter a Density of 0 to start with.
6. Turn off the darkroom lights and place the paper on the easel/baseboard. Use your most popular paper stock, that which is to be represented by paper Emulsion 0. When handling paper, you may turn off the keypad lighting by pressing **DISPLAY**.
7. Make the exposure by pressing **EXPOSE**.
8. Adjust the Density, Magenta, and Yellow values. And make the next test print.
9. Continue making adjustments and test prints until you achieve a perfect print.
10. Once you have made a perfect print, the next step is to make the display read the correct DCMY values (e.g. D64 C0 M30 Y30) for printing a Shirley in your lab. Any values may be used. To do this go into the DIGITAL LIGHT menu and then into the DIGITAL LIGHT Calibration menu.
11. Select item 2, "CALIBRATE MASTER COLOR BALANCE" from this menu and press **ENTER**.
12. You will see the current filtration values displayed, with the cursor flashing on the Density value. You may now replace these values with any numbers you wish. To advance the cursor to the next color, press **ENTER**. If the values are Density 64, Cyan 0, Magenta 30, and Yellow 30, enter: "64 ENTER, 0 ENTER 30 ENTER 30 ENTER." If the Density number is negative and should be positive then press **LAMP +/-**, which will toggle the sign of the number. After the entry for Yellow, pressing **ENTER** will complete the entry of DCMY values. If you enter an incorrect number, press **CANCEL** to regress to the previous value.
13. Once all the filtration values are entered, you will be asked if you would like to calibrate the Density Probe. If you have a baseboard Density Probe for your DIGITAL LIGHT, press **ENTER** now. When **ENTER** is pressed, the Color Dichro Head lamps will turn **on**. If you do not have a Density Probe, press **CANCEL**: the Master Color Balance is now calibrated.
14. You will be asked to take a probe reading. Remove the test negative from the carrier and then put the empty carrier back into the enlarger.
15. Place the Density Probe on the baseboard, centered directly under the lens.

16. Wait for about 6 seconds to let the probe stabilize, then press  to lock in the probe reading.

When the lamp goes out, the Master Color Balance is now set to print a perfect Shirley at the DCMY values entered in step 15.

For future reference it is a good idea to write down the Master Color Balance offsets that were calculated at the end of this calibration operation. With these numbers recorded, you can re-enter these filtration offsets directly without doing the print testing again. This could be useful if an operator accidentally damages the Master Color Balance settings. See Edit Master Color Balance Offsets under Calibration menu of the Reference section of this manual for more information on how to access these offset values.

HOW TO MAKE A PRINT BY TESTING (NO VIDEO ANALYZER)

Summary:

1. Setup your enlarger for printing the negative.
2. Crop the image as desired, using **WHITE** to get white focusing light.
3. Enter an exposure time using **TIME**.
4. Select an Emulsion channel from the main menu.
5. Enter starting filtration values for DCMY using the **DENSITY**, **CYAN**, etc., keys.
6. Take a probe reading (no negative in the carrier, room lights off).
7. Place the carrier, with the negative in place, into the enlarger and check its position.
8. If lamps are in Filters Out mode, press **WHITE** for filtered light.
9. Extinguish lamps using **LAMP +/-**.
10. Place the photographic paper on the easel.
11. Press **EXPOSE** key to make exposure.

At this point, you should have gone through the alignment procedure for aligning to a Master Color Balance. If you are using paper Emulsion offsets, they should already be set up.

1. Setup your enlarger to print the particular negative you are going to print. Use your normal carrier, lens, easel, etc. for production printing.
2. Compose the image as desired for this print. **WHITE** will yield bright, white light for cropping and focusing.
3. Enter the desired exposure time.
4. Choose which paper stock you wish to print on. Select the corresponding paper Emulsion channel (if your Emulsion channels have been setup).
5. Enter the filtrations at which to make this print. If the negative you are printing is a new, unknown negative, enter a filtration the same as you use to print your standard setup (Shirley) negative (e.g. D64 C0 M30 Y30). Use **DENSITY**, **CYAN**, **MAGENTA**, and **YELLOW** to enter the filtration values.
6. If you have a Density Probe, and have calibrated it, take a reading now. This should be done with no negative in the carrier and with the room dark. Place the Density Probe on the baseboard, centered directly under the lens. Press the button on the Density Probe and wait for the probing operation to finish. A "PROBING" message will be displayed during the probing procedure. The probing is automatic and the lamps will go off after a few seconds. Pressing the probe button again or **LAMP +/-** will abort the probing procedure. A message may be displayed instructing you to open or close the aperture.
7. Replace the carrier with the negative installed, check that is in the proper position.

8. The upper left portion of the main display should be showing the DCMY values at which the head is set. If it reads “FILTERS OUT”, press **WHITE** once to bring in the filters for printing.
9. Make sure the Color Dichro Head’s lamps are extinguished, turning them **off** using **LAMP +/-**, if necessary. You are now ready for printing.
10. Place your paper stock on the baseboard or easel.
11. Press **EXPOSE** on the keypad to make the exposure.

After the print is processed, decide what density and color changes are necessary for a perfect print. Use **DENSITY**, **CYAN**, **MAGENTA**, and **YELLOW** to make the appropriate adjustments. Continue making adjustments and test prints until you achieve a perfect print. You do not need to re-probe unless you change the aperture size, re-size the print, or select a different lens.

WORKING WITH A VIDEO ANALYZER (DAILY SHIRLEYS)

Summary:

1. Analyze the setup (Shirley) negative and write down the analyzer values.
2. Setup your enlarger for printing that negative.
3. Enter an exposure time using **TIME** (5 seconds).
4. Select Emulsion channel 0 from the DIGITAL LIGHT menu.
5. Enter a filtration of C0 M40 Y40.
6. Enter a Density of 0.
7. Place paper on easel. Use the most popular paper stock.
8. Expose and process the print.
9. Make test prints until you have a perfect print, adjusting color each time.
10. Go into DIGITAL LIGHT Calibration menu and select Calibrate Master Color Balance.
11. Enter the video values for D,C,M, and Y (64 0 30 30)
12. Press **ENTER** when asked to calibrate Density Probe.
13. Place empty carrier in enlarger, turn off room lights.
14. Place probe directly under lens on baseboard. Wait 6 seconds, then press **ENTER** to complete the procedure.

The DIGITAL LIGHT is capable of working directly with video analyzer printing data. Once the electronics are aligned, any print job can be done on the enlarger by simply entering the video analyzer's DRGB values into the Color Dichro Head. Before doing the alignment procedure, you should refer to the Setting Preferences section to ensure your DIGITAL LIGHT is set up for your specific analyzer. **The procedure given here assumes that the Master Color Balance has not been calibrated.**

1. Analyze your standard setup negative (Shirley) as you normally would. Write down the analyzer's DRGB numbers and take them, with the negative, into the darkroom.
2. Setup your enlarger for printing the Shirley negative. **WHITE** will turn on bright, white light for focusing and sizing.
3. Enter the Exposure time, for your Shirley print.
4. Select Emulsion 0 (zero) in the main menu. Emulsion zero (0) should represent your most popular paper stock.
5. Now enter a value of Magenta 40 and Yellow 40 to start with. Leave Cyan at a value of zero (--).
6. Enter a Density of 0 to start with **DENSITY** is used the same way as the color keys to enter the desired value.

7. Turn out the room lights and place your paper on the easel or baseboard. Use your most popular paper stock, that represented in the DIGITAL LIGHT by Emulsion channel 0.
8. Make the exposure by pressing **EXPOSE**. Process the print by the normal means for your darkroom.

Examine the print and decide what color/density corrections are necessary.

9. Adjust the Density, Magenta, and Yellow values. And make another test print. Continue making adjustments and test prints until you achieve a print with perfect color balance.
10. Once you have made a perfect print, the next step is to make the display read the correct video DRGB vales (the ones written down from the analyzer in step 1) for the negative. To do this go into the main menu and then into the Calibration menu. Select "CALIBRATE MASTER COLOR BALANCE" from this menu.
11. You will see the current filtration values displayed, with the cursor flashing on the density value. You may now replace these values with any numbers you wish. To advance the cursor to the next color, press **ENTER**. If the values are Density 64, Cyan 0, Magenta 30, and Yellow 30, enter: "64 ENTER, 0 ENTER 30 ENTER 30 ENTER." If the density number is negative and should be positive then press **LAMP +/-**, which will toggle the sign of the number. After the entry for Yellow, pressing **ENTER** will complete the entry of DCMY values.
12. Once all the video values are entered, you will be asked if you would like to calibrate the Density Probe. Press **ENTER** to do so. If you do not have a Density Probe, press **CANCEL**; the calibration is now complete.
13. You will be asked to take a probe reading. Remove the test negative from the carrier and then put the empty carrier back into the enlarger. Make sure the room lights are off.
14. Place the Density Probe on the baseboard, centered directly under the lens. Press the button on the Density Probe. The reading will be taken, then the lights will turn off.

The display will go back to the main screen and the filtration will now match the video values. This completes the video analyzer calibration.

For future reference it is a good idea to write down the Master Color Balance offsets that were calculated at the end of the calibration operation. With these numbers recorded you can re-enter these filtration offsets directly without doing the print testing again. This could be useful if an operator accidentally damages the Master Color Balance settings. See Edit Master Color Balance Offsets under Calibration menu in the Reference section of this manual for more information on how to access these offset values.

MAKING A PRINT USING A VIDEO ANALYZER

Summary:

1. Analyze the negative and write down the analyzer values.
2. Setup your enlarger for printing the negative.
3. Enter an Exposure time using **TIME**.
4. Select an Emulsion channel from the DIGITAL LIGHT menu.
5. Enter the analyzer values for DCMY using **DENSITY**, **CYAN**, etc. keys.
6. Take a probe reading (no negative in the carrier, room lights off).
7. Place the carrier with the negative into the enlarger, check position.
8. If lamps are in Filters Out mode press **WHITE**.
9. Position the photographic paper, and press **EXPOSE** to make exposure.
10. If necessary, make color corrections and make tests until perfect color is achieved.

At this point you should have gone through the alignment procedure for aligning to a master video analyzer color balance. If you are using paper Emulsion offsets they should already be set up.

1. Analyze your negative as you normally would in your lab. Write down the resulting DRGB values from the analyzer and take them, along with the negative, to the darkroom.
2. Setup your enlarger for printing the negative. Use a carrier that doesn't allow light to pass around the negative. **WHITE** on the keypad will give you bright unfiltered light for focusing and sizing the image.
3. Enter the desired exposure time.
4. Decide what paper stock you want to print on. If you have setup your paper Emulsion channels, select the Emulsion channel in the main menu which corresponds to the particular paper you are about to use.
5. Enter the filtration values from the video analyzer. Use **DENSITY**, **CYAN**, **MAGENTA** and **YELLOW** to enter these values.
6. Take a probe reading at the baseboard. Be sure to remove the negative while probing. Place an empty carrier into the enlarger. Place the Density Probe on the baseboard, centered directly under the lens. Turn off all room lights. Press the button on the side of Density Probe, and wait for the probing operation to finish. It takes about 6 seconds. The lamps will go off a few seconds after the probe reading is taken. Be sure not to obstruct the light around the probe's sensor "eye" during the probing process.
7. Replace the carrier with the negative in place, check that is in the proper position.

8. The main screen should be displaying the set of filtration values entered in step 10. If “FILTERS OUT” is shown, press **WHITE** to return to filtered light. When the light goes out, the machine is ready for printing.
9. With the room lights and the Color Dichro Head lamps both **off**, place your paper stock on the baseboard or easel, and press **EXPOSE** on the keypad to make the exposure. Process the print as you normally would.
10. If necessary, after the print is processed, decide what density and color changes are necessary for a perfect print. Use **DENSITY**, **CYAN**, **MAGENTA**, and **YELLOW** to make the appropriate adjustments.

Continue making adjustments and test prints until you achieve a perfect print. You do not need to re-probe unless you change the aperture size or select a different lens.

BLACK AND WHITE PRINT MODE

In addition to making color prints, the DIGITAL LIGHT Color Dichro Head is capable of printing variable contrast black and white prints. By simply changing the Print Mode option in the main menu you can change from Color printing to Black and White printing. When in Black and White mode you may select a contrast grade from 0 to 5 in 1/10 grade steps.

Jobs stored in memory while in Black and White mode are stored as black and white jobs. When these jobs are recalled, the Print Mode will automatically be set to Black and White even when recalled from Color printing mode.

To select Black and White mode, press **MENU** and go into the main menu. Then select "PRINT MODE" from that menu and press **ENTER**. Now press **▲** or **▼** to toggle the mode from "COLOR" to "BLACK AND WHITE." Press **ENTER** once to lock in your selection. The display will return to the main screen. In the upper left corner, the display will read "B&W GRADE 0.0" for Black and White mode contrast grade = 0.

When toggling the mode from Color to Black and White, the contrast grade displayed will be the last grade that was used in Black and White mode. When changing from Black and White mode to Color mode, the C,M,Y filtrations will be equal to values used for the grade previously used in the Black and White mode. For example, if you are printing at grade 2.0 and then select Color printing mode the display will read "C:-- M:57 Y:43" which is the same as grade 2.0 in Black and White.

The Black and White printing mode is designed to be used with black and white negatives on variable contrast black and white paper. It will not yield good results if color negatives are used in this mode. To print color negatives, panchromatic black and white paper should be used, the Color printing mode should be selected, with a filtration setting of C:- M:0 Y:0. This will expose the different colored portions of the negative properly yielding the best quality black and white prints from color negatives. To select Color printing mode use the Print Mode option again to toggle the mode to color printing.

THE CONTRAST GRADES USED BY THE DIGITAL LIGHT COMPUTER ARE AVERAGE GRADES ESTABLISHED IN COOPERATION WITH THE PAPER MANUFACTURES. IF YOU CHANGE FROM BW MODE TO COLOR MODE YOU WILL SEE THE FILTER PACK THAT CORRESPONDS TO THE BW CONTRAST GRADE LAST USED, DISPLAYED ON THE KEYBOARD.

THIS IS VERY HELPFUL FEATURE WHEN ESTABLISHING YOUR OWN FILTER PACKS, FITTING INDIVIDUAL GRADE REQUIREMENTS.

HOW TO MAKE A BLACK AND WHITE PRINT BY TESTING

Summary:

1. If necessary, select Black and White mode on the main menu.
2. Setup your enlarger for printing the desired black and white negative.
3. Enter an exposure time using **TIME**.
4. Enter a black and white grade using **CYAN**.
5. Enter a Density value using **DENSITY**. If probing flesh tone, enter the target density.
6. Take a probe reading with all room lights off (remove negative from carrier if not probing flesh tone.)
7. Place the carrier with the negative into the enlarger and re-check position.
8. If lamps are in Filters-out mode, press **WHITE**.
9. If lamps are **on**, press **LAMP +/-**.
10. Place the variable contrast photographic paper on the easel.
11. Press **EXPOSE** to make exposure.

At this point the lenses, carriers, and easels should have been set up. You should have gone through the alignment procedure for aligning the Density Probe in Black and White mode.

1. If the color head is not currently in Black and White mode then select Black and White mode on the main menu.
2. Setup your enlarger for printing the negative. Use a carrier that doesn't allow light to pass around the negative. **WHITE** on the keypad will give you bright unfiltered light for focusing and sizing the image.
3. Enter the desired exposure time, say 5 seconds. Press **TIME** and enter the number of seconds, followed by **ENTER**.
4. Enter a contrast grade value using **CYAN**. Grade 2.0 is a good starting point for an unknown negative.
5. Enter the desired Density value, if you have aligned the Density to a flesh tone value, enter the Density value for the flesh tone target. Press **DENSITY** and enter the value for Density, followed by **ENTER**.
6. Take a probe reading. Temporarily remove the carrier to take the reading if you are not probing flesh tones. Place the Density Probe on the baseboard, centered directly under the lens or under a flesh tone, whichever is appropriate. Make sure all room lights are out. Press the button on the side of Density Probe to start the probing process. Wait for the probing cycle to finish, about 6 seconds. Be sure not to obstruct the aperture on the

Density Probe during the probing cycle. The lamps will go **off** after the probe reading is taken.

7. Replace the carrier with the negative in place, double-check that is in the proper position.
8. The upper left portion of the display should be reading a grade value. If it reads "FILTERS OUT," press **WHITE** to return the lightsource to filtered light output. The DIGITAL LIGHT is now ready for printing.
9. Turn the lamp **off**, by pressing **LAMP +/-**, if necessary.
10. Place your variable contrast paper stock on the baseboard or easel.
11. Press **EXPOSE** on the keypad to make the exposure.

After the print is processed, decide what density and grade changes are necessary for a perfect print. Use **DENSITY** and **CYAN** to make the appropriate adjustments.

Continue making adjustments and test prints until you achieve a perfect print. You do not need to re-probe unless you change the aperture size, print size, or select a different lens.

NOTES ON BLACK AND WHITE MODE

The contrast grades available in Black and White mode are 0.0 to 5.5 in 1/10 grade increments. Due to differences in black and white papers and black and white light sources, the grades available on the DIGITAL LIGHT may not exactly match the grades on other equipment. For example, it may be necessary to use a grade 2.4 to match a grade 2.0 on another piece of equipment. It will be necessary to test the DIGITAL LIGHT over the entire grade range to determine the best grade choices for the black and white printing you do.

The grades are pre-programmed to be density balanced for ease of operation. If you make a print at grade 2.0 and then just change the grade to 4.0, the middle gray tones of the print will remain the same and the tones above and below will be expanded yielding a higher contrast print, without a density shift. This facility makes it easy to make many test exposures at different grades, without re-testing for density changes. This density-balanced operation is achieved by adjusting the light output for each grade, grade 0.0 requiring the brightest light and grade 5.0 requiring the least light.

SETTING UP PAPER STOCK EMULSIONS

Summary:

1. Select Emulsion 0 in menu and make a perfect Shirley print on the corresponding paper.
2. Select Emulsion 1 and make a print on the new paper (the paper to be used for emulsion 1).
3. Determine what color/density corrections are needed. Access the Emulsion menu.
4. Press to edit Emulsion 1 offsets. Enter the color change values.
5. Make a test print with the adjusted Emulsion 1, again using Emulsion 1 paper.
6. Make further corrections, always using the Emulsion menu item.

The DIGITAL LIGHT Color Dichro Head is capable of using 24 separate paper stock Emulsions as well as an empty Emulsion (Emulsion 0). Different paper stocks have slightly different sensitivities to light, making it difficult to make the same exact print on different paper stocks. By assigning a set of color offset values to each paper stock you can change from paper to paper and achieve the same print by simply selecting the Emulsion offset in the main menu.

Before setting up paper emulsions you need to choose which emulsions will be used with the enlarger, and decide which emulsion is most commonly used. Write down a list of the emulsions and the numbers which you want to assign each emulsion. The most popular emulsion should be Emulsion 0 (zero). Post the list next to the enlarger.

Example:

<u>Emulsion</u>	<u>Paper Emulsion</u>
0	Kodak 8 X 10 -- Most commonly used
1	Kodak 11 X 17
2	Kodak 16 X 20
3	Kodak 20 X 24
4	Fuji 8 X 10

Calibrating an Emulsion channel involves making a perfect print on your most common paper stock, from your standard (Shirley) negative. When this is done, another print is made on the new paper (the one which is to be set up) and the color is corrected using the Emulsion option in the main menu, rather than entering the filtration on the main screen. The steps for setting up an Emulsion channel are as follows:

1. First select Emulsion 0 from the main menu. Use your standard setup negative (Shirley) and make a perfect print on your Emulsion 0 paper stock to use for comparison. See the sections in this chapter: Making a Print by Testing or Making a Print With a Video Analyzer for the procedure of making the perfect print for this step.

2. To setup Emulsion 1, select Emulsion 1 from the Emulsion menu by getting into the main menu and selecting Emulsion. The display will read “EMULSION: 0” in the upper, left corner, with a cursor flashing on the ‘0.’ Select Emulsion number 1 by pressing then . The offset values displayed on the bottom line of the display will now be updated to show the values for Emulsion 1. Press again to lock in the selection of Emulsion channel 1. Make a print on the Emulsion 1 paper stock. It will Probably be a little different from the previous print on the Emulsion 0 paper.
3. Examine the new print and decide what color adjustments are needed to match the first print. To put in the corrections **do not use the filtration entry on the main screen.** Instead, use the “EMULSION” item in the main menu as in the last step. The display should read “EMULSION: 1” and below, “D: 0 C: 0 M: 0 Y: 0.”
4. Press to edit the color corrections. The cursor will now be at the value for Density (‘D’);. If a correction for density is needed, enter the value by which to change the density. (For example: if you determine that the print 5 CC’s too dark, enter ‘5’ for the density change.) Use to toggle between positive and negative numbers.
5. Press to move to the next color entry. Continue in this manner until the Yellow change value is entered. When all color changes are entered, the cursor will move back to the top line, under the emulsion number entry. This allows you to elect a new emulsion if you want, but simply press to stay with the emulsion you've just adjusted.
6. Now that the corrections have been put in, make another test print.
7. When the new print matches the first print perfectly, then Emulsion 1 has been successfully setup. If it requires more adjustments, use the Emulsion option in the main menu to make further corrections. Again, do not use the regular color entry on the main screen for adjusting Emulsion offsets.

When new batches of paper come in you may find it necessary to re-test and re-adjust the Emulsion offsets to maintain perfect compatibility.

Now when you want to use paper Emulsion 1, you simply need to select it from the Emulsion option in the main menu.

For your convenience, the Emulsion number currently selected is always displayed on the main screen to the right of the Yellow filtration value. Before making an exposure glance at that number and refer to your Emulsion list to verify the correct Emulsion is selected for the paper you are printing on.

To setup the other Emulsions go through the same procedure as you did for Emulsion 1. Always match the test print with the print you made on your Emulsion 0 paper.

SETTING AND MAINTAINING PROCESS OFFSETS

Summary:

1. Select Emulsion 0 from the main menu.
2. Use your most popular paper stock.
3. Enter your standard filtration for D,C,M, and Y (64 0 30 30).
4. Take a probe reading.
5. Make a print with your setup negative (Shirley).
6. Determine the D, C, M, and Y corrections if any.
7. Go into Calibration menu.
8. Select "EDIT PROCESS OFFSETS."
9. Enter the corrections for D, C, M, and Y (e.g. D 2 C0 M-2 Y0)
10. Make another print with your setup negative (Shirley).
11. Adjust the corrections again using the Process offsets option.
12. Continue testing until print is perfect.

It is a common problem in professional color labs to have color shifts in prints due to changes that occur in the color paper processor. The changes are greatest day to day but also occur through the course of a day. One way to compensate for processor drift is to manually adjust the filtration of each job as it comes from the video analyzer. Another way to compensate is to adjust the Master Color Balance offsets in the Calibration menu, but those numbers are used specifically for video analyzer alignment and are not convenient numbers to be adding to and subtracting from. The DIGITAL LIGHT has a specially designed feature for handling process drifts.

In the Calibration menu there is an option called "EDIT PROCESS OFFSETS." This feature allows you to put in and take out small color corrections easily that will effect all exposures made regardless of which emulsion (paper) is selected. The correction numbers entered here, like those entered when adjusting an Emulsion channel, are color correction changes. You do not enter the actual filtration values displayed on the main screen.

For example, if you align to your video analyzer on Monday, and make prints all day with no problem, and then Tuesday morning your print your Shirley and it needs a little correction then you should make a Process offset change.

If you examine the print from the Shirley and determine it needs 3 CC's of density and 2 CC's of yellow for example, make the corrections as follows:

From the main menu, access the Calibration menu. Select the Edit Process Offset option and enter 3 for the Density value, press **ENTER** until you are on the Yellow value and enter 2. Press **ENTER** after the Yellow entry to exit. The new offsets will now be in effect.

Those Process offsets can be adjusted as frequently, or infrequently, as necessary for your lab. The Process offsets are easy to maintain because their values are all close to 0, making them easy to adjust for tracking processor drifts.

KEYPAD OVERVIEW:

This section covers the operation of the keys on the keyboard – how to use them and what they are used for. The main screen information is also explained.

Lamp On and Off Control

Use **LAMP +/-** to turn the lamps **on** and **off**. When in white light mode the lamps turn **off** immediately. When the DIGITAL LIGHT is in filtered color mode, the lamps will only turn **off** if the head is on perfect color. This may cause a delay of a few seconds, which is normal.

Exposure time Entry

Use **TIME** to enter an exposure time in seconds. The allowable range is from .1 to 999.9, however we recommend keeping the exposure time above 1 second for optimum performance. **NOTE:** the displayed density will change when the exposure time is changed unless the Time to Density Correction preference is Inactive. See the section for the Preferences menu.

Making an Exposure

Use **EXPOSE** to start an exposure. An exposure starts with the lamps turning on for a split second before the shutter opens. When the shutter opens, the internal timer will start to count down to 0 (zero), clicking every second for dodging and burning. The print counter will count up or down one exposure, depending on the how the print counter target is set.

Be sure that the head is not in White Light mode when making an exposure. If the display reads “FILTERS OUT,” simply press **WHITE** to return to filtration mode. Also, be sure the color filtration is set before trying to start an exposure. If the filtration is not set when **EXPOSE** is pressed, the Color Dichro Head will beep and the keypad’s display will read “FILTERS NOT SET.” This indicates that the filters are in an unknown state. This is remedied by entering a color correction value for any of the Density, Cyan, Magenta, or Yellow settings. Another quick way to do this is to turn the lamps **on**, then **off**, by pressing **LAMP +/-** twice.

Density Entry

To enter a new density value press **DENSITY**, enter the numerical value for the new density and press **ENTER**. You can also adjust the density by pressing **DENSITY** and then using **▲** or **▼** to increase or decrease the density value. When you press **ENTER** the light will come on, the Color Dichro Head will adjust for the new density, and the light will turn off. If the light source can not make the density change, the exposure time will be adjusted automatically to make up for the rest of the density change using time.

Cyan, Magenta, and Yellow Filtration Entry

The CMY values can be entered using **CYAN**, **MAGENTA** and **YELLOW**. The operation is identical for all three color channels. Press the appropriate color key and then enter the numerical value for the filtration, or use **▲** or **▼** to increment or decrement the value. Press **ENTER** to complete the filtration entry. The lamps will turn on as the filtration is set, turning off only after a perfect filtration is reached. A few seconds delay while this occurs is normal. The light source does have limits on the filtrations it can reach, and if you enter a value outside the limits the filtration will be adjusted to the closest value it can reach. The limit values (maximum filtration values) will also change depending on what the various offsets are set to. **NOTE:** The CMY values are always normalized to the lowest filtration value (usually cyan). One of the three colors will always be forced to 0 and be indicated by a '--' in the display.

Print Counter Operation

On the main screen, the current print count is displayed. The count may be reset using the print count selection in the main menu. The print counter can count up or down depending on your preference. For example if you want to make 10 prints, you can enter a quantity 10 in the main menu, which will tell the DIGITAL LIGHT you want to make ten prints. Each exposure will decrement the count on the main screen until the count reaches 0 (zero). Upon reaching 0 the keypad beeps three times to let you know the 10 prints are done. Entering a value of 0 (zero) into the counter will cause it to merely keep track of the number of prints made thereafter. With each exposure the count will increment until the count reaches 999 when the count stops.

Job memory Save

The DIGITAL LIGHT currently has 250 job memory channels that can be used to store specific print jobs. The information stored is the D,C,M, and Y filtration settings, exposure time, emulsion number, and f-stop. The f-stop is used only for the operators reference and is not used in any of the calculations. To save a job press **SAVE**. You will be prompted for a job number: enter a five digit number of your choice, then press **ENTER**. If that number is already in use you will be asked if you would like to over-write the old job information. Next you will be prompted for a f-stop value, you may enter a f-stop value if you wish, it will be displayed when the job is recalled. It is a good practice to always save the setup during test printing to ensure that you are printing with the latest print data.

Job Memory Recall

To recall or load a job that was previously saved press **RECALL**. You will be prompted to enter a job number. Enter the job number and press **ENTER**. If a previously-stored job by that number is not found the display will show “DOESN’T EXIST, TRY AGAIN.” When a job is recalled the light will turn on and the filtration will be put in, as the recalled f-stop is displayed for a few seconds. The display will then go back to the main screen and light will turn off. The DIGITAL LIGHT is now ready for printing.

LCD Display and Key Backlights Control

Use **DISPLAY** to turn the keypad backlighting on and off. When off, the expose and display keys are dimly lit so you can easily find them in the dark. On the back of the keypad you may adjust the backlights brightness with the small adjustment knob. The LCD display contrast can be adjusted on the back of the keypad with a small slotted screwdriver. Large changes in room temperature may cause the display contrast to change.

Density Probe Operation

The baseboard Density Probe is primarily used to keep the Color Dichro Head density calibrated. An 8x10 print that prints at D64 should also yield the same print density when enlarged to 11x17 and the density should still read D64, the difference is measured by the DIGITAL LIGHT, which needs to make up for the light falloff by increasing the time or increasing the light output. This adjustment is done using the Density Probe. When you click on the Density Probe button, the lamps will turn **on** while the density at the baseboard is measured. During this time, the keypad will display the word “PROBING...” in the upper left area of the screen. The probing cycle will finish automatically when a stable probe reading is taken. At that time the lamps will be adjusted to the correct density and then the lamps will switch **off**. Refer to Density Probe Manual for further information.

This menu item displays the current lens that DIGITAL LIGHT is using to apply lens color and density offsets for. It should match the lens that is displayed when **SETUP** is pressed. Use this menu item for scrolling through the lens list to select a lens for applying the color and density offsets. These offsets work in a similar manner as emulsion offsets. Each emulsion has a set of offsets and similarly each lens has a set of offsets.

->4: PROCESS PROC#: 0

Allows selection of which Process offset will be used in current operation. Process offsets are generally used to correct for the small changes in print color balance caused by processor chemical changes. The DIGITAL LIGHT features nine different Process offsets in case your Color Dichro Head is making prints that are fed into multiple processors in your lab.

->5: PREFERENCES

Selecting “PREFERENCES” from the main menu will get you into this sub-menu . From the Preferences menu you may adjust the DIGITAL LIGHT ’s factory-set preferences, such as: maximum lamp power level, whether the density number increases or decreases with increasing light output, etc. **NOTE:** you must press **CANCEL** exit the Preferences menu

->6: CALIBRATION

Selecting “CALIBRATION” from the main menu will get you into this sub-menu. To make day-to-day and other periodic color balance adjustments, use the selections in this menu. Some of the items you can adjust are the Master Color Balance (VCNA balance) and Process corrections.

->7: MAINTENANCE

Selecting “MAINTENANCE” from the main menu will get you into this sub-menu . Use the selections in this menu to erase job memories, and perform other memory maintenance operations.

->8:

DIAGNOSTICS

Selecting “DIAGNOSTICS” from the main menu will get you into this sub-menu . Use the selections in this menu to perform troubleshooting operations.



->9:

DODGE & BURN BEEPS

To set the exposure timer to beep at specific times for assistance in dodging and burning use this option. There are three beeps that can be individually set to any value from 0.0 to 999.9 seconds. If all the beeps are set to 0.0 then the timer will click every second as usual. If any of the beeps are set to a non-zero time the keypad will beep at that time during the exposure. You may use any combination of the beeps, the first beep in the list does not have to be the first beep during the exposure.

->10:

PRINT MODE (COLOR)

The DIGITAL LIGHT Color Dichro Head is capable of either color printing, with standard D,C,M, and Y filtration values, or printing black and white, using variable contrast grades. This Print Mode preference allows the user to select between the two modes. To toggle between the two settings, select this item from the Preferences menu , and press .  or  will then toggle between the Color and the Black and White modes. Calibrations (density probe alignment, etc.) for each mode do not affect the other: the DIGITAL LIGHT maintains a separate set of calibration information for each of the two modes. For more information on printing in black and white, please refer to Selecting Black and White Mode and the following items in the Advanced Operations section of this manual

PREFERENCES MENU

ACCESS THROUGH ITEM 5 IN DIGITAL LIGHT MENU.

1: SIZE TO DENSITY CORRECTION	INACTIVE
2: SHUTTER	ACTIVE
3: DENSITY SLOPE DIRECTION	NEGATIVE
4: TIME TO DENSITY CORRECTION	ACTIVE
5: MAXIMUM LAMPS POWER	90%
6: AUTO LAMP SHUTOFF	ACTIVE
7: DISPLAY MODE	CMY
8: PROBING LIGHT	WHITE
9: PROBE WITH AUTOCORRECTION	ACTIVE
10:LAMP POWER DISPLAY	INACTIVE
11:FILT. DENSITY CORRECTION	INACTIVE
12:ROLL EASEL SETTINGS	

A NOTE ABOUT THE PREFERENCES MENU: Unlike the other menus, you do not exit this menu when one item is selected. The computer stays in this menu after each selection is made until you press **CANCEL**.

->1: SIZE TO DENSITY CORRECTION INACTIVE

Used in conjunction only with Auto focus enlargers, this selection sets whether or not the DIGITAL LIGHT will automatically adjust density when the operator makes a change in magnification.

->2: SHUTTER ACTIVE

The internal shutter may be “ACTIVE” or “INACTIVE”. When active, the shutter opens and closes with lamp turn-on and turn-off, but during exposures, the lamps come on one half-second before the shutter opens to allow the lamps to come up to full power before exposing. This allows consistent exposures with short (down to one-second) exposure times. When inactive, the shutter remains open at all times, and at the start of an exposure, there is no half-second period for lamp warm-up. Generally, this selection is inactive only if using the DIGITAL LIGHT on a slide duping camera, photo printer, or similar device.

->3: DENSITY SLOPE DIRECTION (POSITIVE)

The density slope direction can be either “POSITIVE” or “NEGATIVE”. When positive, the density number increases as the light output increases. When set to negative, the density number decreases as light increases. This should be set to match your video analyzer operation or the operator's preference.

->4: TIME TO DENSITY CORRECTION - ACTIVE

The time to density correction can be “ACTIVE” or “INACTIVE”. When Active, any changes to the exposure time will be reflected in a density change of the appropriate amount, as if the light source was made brighter or dimmer by the change in time. For example, changing the exposure time from 5.0 to 10.0 seconds would change the density by 30, one stop. This makes the density value represent the density of the resulting print, rather than just the brightness of the lamps. If you do not wish the density number to change when the exposure time is changed, set this item to Inactive.

->5: MAXIMUM LAMPS POWER 90%

The maximum power that may be applied to lamps can be set with this preference. The range is from 60 to 99%. If set to 99%, the lamps will be allowed to run at just about their rated power/voltage, yielding maximum brightness. A power level of a just a few percent less will greatly increase lamp life. The factory setting for the power level is 90%. When exiting the Preferences menu, the lamps will go through a quick re-calibration cycle if you change the power level. **NOTE:** this item sets the maximum power level, and it is in effect only when the color head is trying to reach a bright density level, which may not be very often, depending on what type of printing you do. It does not lock the lamp power at a specific level. It merely sets an upper limit.

->6: AUTO LAMP SHUT OFF - ACTIVE

The DIGITAL LIGHT Color Dichro Head will automatically turn **off** its lamps after 5 minutes of non-operation. That is, if the Color Dichro Head is left with its lamps **on**, it will wait 5 minutes, then shut them **off** automatically. This feature is designed to save lamp life if an operator leaves the darkroom with the DIGITAL LIGHT lamps **on**. This automatic lamp shutoff may be disabled if desired.

->7: DISPLAY MODE CMY OR RGB

The color printing display on the keypad can be set to two different modes. The factory setting is the D: C: M: Y: mode representing Density, Cyan, Magenta, and Yellow. It may be more convenient to use the RGB mode which is displayed as D: R: G: B:. Representing Density, Red, Green, and Blue which are the complimentary colors to Cyan, Magenta, and

Yellow. Both display modes work identically, the only difference is the letter representing the individual color channel. We recommend using whichever mode you are used to. If you use a video analyser the RGB mode is recommended.

->8: PROBING LIGHT - WHITE

The probing light can be set to “WHITE” or “FILTERED”. This affects the light while the Density Probe is taking a measurement. In most situations the probing light should be set to “WHITE” to properly track video analyzers. You may want to set it to “FILTERED” light if you do not use video analyzers and are probing for flesh tones on the image.

->9: PROBE WITH AUTO CORRECTION - ACTIVE

The probe with auto correction setting can be “ACTIVE” or “INACTIVE”. When Active the lamps Density is automatically adjusted brighter or dimmer while the probing operation takes place. This is the most common setting since it makes corrections for aperture and sizing changes without print testing. If this mode is set to “INACTIVE” then the lamps Density is not changed by the probe and during the probing a density reading is simply displayed at the “D:” value on the main screen. This is useful if you want to use the probe as a metering device only.

->10: LAMP POWER DISPLAY INACTIVE

If this option is set to “ACTIVE”, you will see a “PWR:” readout on the main screen whenever the lamps are turned **on**. This readout replaces the print counter readout until the lamps are turned **off**. The power level, which can range between about “30%” and whatever value you have set for the Maximum Lamps Power, is a good indicator of how much power you have left for density changes.

->11: FILT. DENSITY CORRECTION INACTIVE

This item allows you to turn on or off the Filtration to Density Correction feature of the DIGITAL LIGHT. This feature allows the user to assign percentage values to each of the three filtration colors (C, M, and Y). For each color, the assigned percentage of it’s filtration value will be added to the Density value in order to track density change due to filtration changes. This is used to make the work with *visual* density rather than *neutral* density. Some older video analyzers use visual density, but for most users, this preference should be made “INACTIVE.”

->12:

ROLL EASEL SETTINGS

This menu option is used to select the settings for the Roll Easel interface connections that are located on the 25 pin IO connector on the DIGITAL LIGHT.

ROLL EASEL SETTINGS MENU

ACCESS THROUGH ITEM 12 IN DIGITAL LIGHT PREFERENCES MENU.

- 1: ROLL EASEL INPUT**
- 2: ROLL EASEL OUTPUTS**
- 3: ROLL EASEL TIMING**

The DIGITAL LIGHT Color Dichro Head features two output relays and an optically-isolated input line for interfacing to a roll easel. The operation of these relays and signal line is determined using this menu. Different roll easels operate in different ways, thus the settings in this menu must be set to operate with your particular roll easel model.

->1:

ROLL EASEL INPUT

Use the options in this menu to select the Roll Easel Input operation. This is the way the roll easel gives the DIGITAL LIGHT instructions. There are different possible setups. For example you may want the DIGITAL LIGHT to start an exposure when a pulsed signal is received from the roll easel. Or you may want the DIGITAL LIGHT lamps to come **on** momentarily only when a signal is present from the roll easel. The input signal is connected at the 25 pin IO connector.

->2:

ROLL EASEL OUTPUTS

Use the options in this menu to select the Roll Easel Output Relay settings. There are two mechanical relays in the DIGITAL LIGHT that can be setup to open or close their contacts in various ways. The relay contacts are connected at the 25 pin IO connector.

->3:

ROLL EASEL TIMING

Use the options in this menu to select the various delay times that apply to the Roll Easel Output settings for the two relay controls.

If you own a Brooke, Fotoba, or Rollma brand roll easel we recommend you use the following settings for best performance:

Roll Easel Input: 1: Start Expose On Switch Closed On

Roll Easel Output:3: End Expose Relay Closed RL1 ---

All other outputs off, set to “---”

Roll Easel Timing:2: End Pulse Time .5 seconds

3: End Delay Time .3 seconds

Request schematic drawings from DURST-PRO-USA

ROLL EASEL INPUT MENU

ACCESS THROUGH ITEM 1 IN THE ROLL EASEL SETTINGS MENU.

1: START EXPOSE ON SWITCH CLOSED	ON
2: START EXPOSE ON SWITCH OPEN	OFF
3: LAMP ON WITH SWITCH CLOSED	OFF
4: LAMP ON WITH SWITCH OPEN	OFF
5: SYSTEM HOLD WITH SWITCH CLOSED	OFF
6: SYSTEM HOLD WITH SWITCH OPEN	OFF
7: AUTO RESTART EXPOSE (NO INPUT)	OFF

The Roll Easel Input signal is generally a signal from the roll easel that tells the DIGITAL LIGHT when to start a new exposure, using the timer in the DIGITAL LIGHT to determine the length of the exposure. The roll easel does this by closing a relay inside the roll easel, and via a connecting cable to the DIGITAL LIGHT activates a circuit in the color head that senses the relay closing. The connection is on pins 1 and 14; on the 25 pin connector. The roll easel should supply “dry contacts” on it’s relay, if the roll easel supplies 120 volts AC or some other voltage, do not connect directly to pins 1 and 14 this will damage the electronics/CPU

->4: LAMP ON WITH SWITCH OPEN OFF

This mode is similar to the previous, except the lamps are **on** when the relay is open and the lamps are **off** when the relay is closed.

->5: SYSTEM HOLD WITH SWITCH CLOSED OFF

or

->6: SYSTEM HOLD WITH SWITCH OPEN OFF

These two modes are used to prevent the DIGITAL LIGHT from starting an exposure because the roll easel or other equipment is not ready. When the signal is activated, a message will appear on the display if an exposure is attempted.

->7: AUTO RESTART EXPOSE (NO INPUT) OFF

This mode is used when the roll easel is set up as a slave unit. This is convenient for roll easel models that only have a paper advance input. The DIGITAL LIGHT controls all aspects of the print run. You set the number of prints with the print counter in the main menu . After pressing **EXPOSE** the color head makes an exposure, then pauses the time set in the “PAPER ADVANCE TIME” and then continues to make exposures until the print counter reaches 0. Normally you would set the Roll Easel Output for “END EXPOSE RELAY CLOSED RL1” to signal the paper advance at the end of an exposure. Set the “PAPER ADVANCE TIME” long enough to allow for the roll easel to advance through the longest print you will be using.

ROLL EASEL OUTPUTS MENU





ACCESS THROUGH ITEM 2 IN THE ROLL EASEL SETTINGS MENU

- 1: **START EXPOSE RELAY CLOSED** --- ---
- 2: **START EXPOSE RELAY OPEN** --- ---
- 3: **END EXPOSE RELAY CLOSED** --- ---
- 4: **END EXPOSE RELAY OPEN** --- ---
- 5: **EXT SHUT RELAY CLOSED** --- ---
- 6: **EXT SHUT RELAY OPEN** --- ---
- 7: **EXT SHUT RELAY CLOSE EXPOSE** --- ---
- 8: **EXT SHUT RELAY OPEN EXPOSE** --- ---
- 9: **LAMP BLOWN RELAY CLOSED** --- ---
- 10: **LAMP ERROR RELAY CLOSED** --- ---
- 11: **PLATEN CONTROL RELAY CLOSED** --- ---

In this menu the Roll Easel Outputs are signals sent to the roll easel from the DIGITAL LIGHT in the form of relay closures controlled by the DIGITAL LIGHT. There are two mechanical relays in the DIGITAL LIGHT, both are connected to the 25 pin IO connector and both relays can be set to any of the modes shown above. When Relay 1 is Active for one of the settings “RL1” will appear just to the right of the option. Similarly Relay 2 will appear as “RL2” in the next column when Active. The signals are provided as dry contacts on the 25 pin IO connector. Relay 1 is connected on pins 12 and 13. Relay 2 is connected on pins 24 and 25. The standard setup for a roll easel would be the relay close on end of exposure. In this case the DIGITAL LIGHT would signal the roll easel to advance the paper at the end of an exposure.

The start, end, and end delay times are set in the Roll Easel Timing menu .

Refer to the IO connector wiring diagram for details on the electrical hook-up.

Select an option by pressing  then  or  to toggle the option and then press  again.

->1: **START EXPOSE RELAY CLOSED** --- ---

This selection causes the relay to momentarily close at the start of an exposure. The duration of the relay closure is set by the Start Pulse Time in the Roll Easel Timing menu.

->2: START EXPOSE RELAY OPEN --- ---

This selection causes the relay to momentarily open at the start of an exposure. The duration of the relay opening is set by the Start Pulse Time in the Roll Easel Timing menu.

->3: END EXPOSE RELAY CLOSED --- ---

This selection causes the relay to momentarily close at the end of an exposure. The duration of the relay closure is set by the End Pulse Time in the Roll Easel Timing menu . There is also a delay that can be set so after the exposure is done the End Expose signal comes a little time after the exposure is finished. This End Pulse Delay would be used if you are using the relay closure to advance the paper but you desire a short pause before the paper starts advancing. The delay time can be set in the Roll Easel Timing menu.

->4: END EXPOSE RELAY OPEN --- ---

This selection causes the relay to momentarily open at the end of an exposure. The duration of the relay opening is set by the End Time in the Roll Easel Timing menu. There is also a delay that can be set so after the exposure is done the End Expose signal comes a little time after the exposure is finished. This End Pulse Delay would be used if you are using the relay opening to advance the paper but you desire a short pause before the paper starts advancing. The delay time can be set in the Roll Easel Timing menu .

->5: EXT SHUT RELAY CLOSED --- ---

This selection is used when an external shutter is used. Whenever the lamps come **on** the relay closes to open the external shutter. When an exposure is made the lamps come **on** for .5 seconds before the external shutter is activated to allow the lamps to come up to temperature before the external shutter is opened, this allows for more accurate prints.

->6: EXT SHUT RELAY OPEN --- ---

This selection is used when an external shutter is used. Whenever the lamps come **on** the relay opens to open the external shutter. When an exposure is made the lamps come **on** for .5 seconds before the external shutter is activated to allow the lamps to come up to temperature before the external shutter is opened, this allows for more accurate prints.

->7: EXT SHUT RELAY CLOSE EXPOSE --- ---

This selection is used when an external shutter is used. Only when the DIGITAL LIGHT makes an exposure the relay closes to open the external shutter. When the lamps are turned using

LAMP +/- or WHITE, the external shutter is not activated.

->8: EXT SHUT RELAY OPEN EXPOSE --- ---

This selection is used when an external shutter is used. Only when the DIGITAL LIGHT makes an exposure the relay opens to open the external shutter. When the lamps are turned using

LAMP +/- or WHITE, the external shutter is not activated.

->9: LAMP BLOWN RELAY CLOSED --- ---

This selection causes the relay to be closed when the lamps have been detected as blown, thus signaling some other equipment or switching on a error light for the operators attention when doing a roll easel run of prints.

->10:LAMP ERROR RELAY CLOSED --- ---

This selection causes the relay to be closed when there is an error in light outputs, thus signaling some other equipment or switching on a error light for the operators attention when doing a roll easel run of prints.

->11:PLATEN CONTROL RELAY CLOSED --- ---

This setting causes a relay to control the platen found in some roll easels and photo printers. The platen is a back plate that covers the area where the paper lies during exposure. When activated the platen in such a machine will press against the paper in order to flatten it out during an exposure. In operation, the platen will be activated just before the exposure starts and released just before the paper advance starts.

->3: END DELAY TIME

0.5 SECONDS

The End Delay Time is the duration of the delay between the time the exposure ends and the End Pulse (paper feed) starts. This delay ensures the paper feed does not start until well after the exposing lamp is **off**.

->4: ERROR PULSE TIME

0.2 SECONDS

The Error Pulse Time is the duration of the relay closure if one of the Roll Easel outputs is configured to activate on a lamp error or blown lamp. This time should be set sufficiently long to reliably trigger the circuitry in your roll easel or printer.

->5: PAPER ADVANCE TIME

0.2 SECONDS

This time is the pause time in between exposures when the Auto Restart Expose mode is used for the Roll Easel input. Set this time longer than the longest time the roll easel takes to advance one exposure.

->6: EXT SHUT LAMP DELAY

2.0 SECONDS

This is the amount of time that the lamps stay **on** after the end of an exposure with an external shutter. This is used to keep the lamps from turning **off** then **on** again between exposures on roll easels. This delay should be set sufficiently long for the lamps to wait for the paper to advance to the next exposure, without turning **off**. This way, the lamps will burn continuously through the run of prints, causing less lamp fatigue than if they were to turn **off** during each paper advance, then **on** again for each new exposure.

CALIBRATION MENU

ACCESS THROUGH ITEM 6 IN THE MAIN MENU.

- 1: EDIT PROCESS OFFSETS**
- 2: CALIBRATE MASTER COLOR BALANCE**
- 3: EDIT MASTER COLOR BALANCE OFFSETS**
- 4: EMULSIONS**
- 5: EDIT LENS OFFSETS**
- 6: CALIBRATE B&W PROBE DENSITY**
- 7: EDIT 2X2 MIXING CHAMBER OFFSETS**
- 8: CALIBRATE 2X2 MIXING CHAMBER**
- 9: EDIT VC-SCAN CHANNELS**
- 10: EDIT COLOR PRO STYLES**
- 11: EDIT COLOR PRO FILMS**
- 12: EDIT COLOR PRO CALIBRATION VALUES**
- 13: FILT DENSITY CORRECTION GAINS**

->1: EDIT PROCESS OFFSETS

With this selection you can make daily corrections to your D,C,M, and Y Process offsets. These values are incremental and absolute; they are added to the D,C,M,Y values on the main screen. If a value of 3 is entered for Cyan then 3 points of Cyan will always be added to Cyan. These values will remain in the DIGITAL LIGHT from day to day, and you can refer to them and edit them as needed. **NOTE:** you can make density corrections using the D value or by changing C,M, and Y equally. We recommend using the D entry for simplicity.

->2: CALIBRATE MASTER COLOR BALANCE

This calibration routine allow you to assign any main screen filtration values to the current filtration setting. This is used for initially calibrating the DIGITAL LIGHT Color Dichro Head to your lab standard filtration. A summary of the procedure follows:

1. Make a perfect standard (Shirley) print. It does not matter what the main screen filtration values are, as long as the print is perfect.
2. Start this “CALIBRATE MASTER COLOR BALANCE” routine. You will be presented with a screen that shows the numeric filtration values to which the DIGITAL LIGHT is currently set.

3. Type your new values over these values. The new values are what the filtration should read when the perfect Shirley print is made. (For example: D:64 C:0 M:30 Y:30). Use **ENTER** to advance to the next value in line, from left to right. **CANCEL** will retreat to the previous value, one to the left. Pressing **ENTER** after typing the last value, Yellow, will start the next step of this routine. Pressing **ENTER** while entering the first value, Density, will cancel this routine with no changes made.
4. The next screen will ask if you wish to calibrate the Density Probe. If you do not have a Density Probe press **CANCEL** to complete the Master Color Balance Calibration.
5. If you have a probe press **ENTER**. You will be asked to remove the negative from the carrier, put the carrier back in the enlarger, then press **ENTER** to take a probe reading. Follow these directions, making sure that the Density Probe is in position directly under the lens.
6. With the D-Probe in position, press either the Probe button or **ENTER** to complete the Master Color Balance Calibration procedure.

->3: EDIT MASTER COLOR BALANCE OFFSETS

This selection is used to view and edit, if necessary, the master offsets that are normally established using the Calibrate Master Color Balance selection. When you do a Calibrate Master Color Balance operation and enter the new values that are to be use at the main screen, you are over-writing the old values. What the computer actually does, is to generate a set of offset values equal to the difference between the new values and the old. These offsets are thereafter always added to the old values to get the new values. The offset values are directly accessible from this menu selection.

After performing a Master Color Balance calibration, it is a good idea to write down these offset values in case something happens to the calibration of the color head. Re-entering these values after an accidental re-calibration will get you back to your good calibration.

->4: EMULSIONS

Emulsion offsets are used to compensate for different papers. The Emulsions selection in this menu is the same as the Emulsion selection in the main menu. Please refer to that section for details.

->5: EDIT LENS OFFSETS

With this selection you can make the DIGITAL LIGHT correct color differences in different lens. You may edit the Density, Cyan, Magenta, and Yellow offsets for each lens. Another way to select a lens is at the main menu under the "SELECT LENS" option. The Lens offsets are very useful if you choose not to use the Density Probe and keep all of the lens apertures locked at a constant aperture. In this case you can "balance" the Lens Density offsets so all of the lenses print at the same density regardless of which lens is used.

->6: CALIBRATE B&W PROBE DENSITY

This calibration procedure allows the user to set the Density Probe to read any amount of light on the baseboard, and assign it any Density ('D') value for display on the main screen. With this calibration, for instance, an operator can probe a skin tone and assign it a value of D:100. Thereafter, any new black and white negative can be loaded, then the baseboard image of its flesh-tone can be probed. The color head will then adjust to match the new skin tone to the standard exposure set with this preference.

This is only one example; please refer to the Density Probe manual for more detailed information.

-> 7 & 8 INSTALLING A NEW MIXING BOX

DIGITAL LIGHT is operating with only one mixing box. ONLY 4x5" systems have the option of working with two mixing boxes.

DIGITAL LIGHT is constructed with one main mixing chamber feeding all exchangeable mixing boxes. Therefore a new calibration for each mixing box is NOT necessary.

You will therefore not be slowed down by a power down/up of the DIGITAL LIGHT and will be able to switch mixing boxes very quickly during production.

Please avoid ITEM 7 & 8 on the calibration menu they need not and should not be attempted on a DIGITAL LIGHT Color Dichro Head..

COMPENSATION FOR DIFFERENT MIXING BOXES ARE INSTEAD HANDLED VIA THE PAPER CHANNELS.

Use the following procedure to balance extra mixing boxes on DIGITAL LIGHT heads:

1. Make a perfect print from your shirley / master negative with your standard mixing box.
2. Install the new mixing box, install the lens used with that mixing box, leave the shirley negative in the negative holder.
3. Make a new perfect print of the section of the shirley that are now being used by the new lens.
4. Calculate the difference in exposure (D) and color between your master / shirley and your new section of that same shirley.
5. After the offsets are edited, make another Shirley print. Continue adjusting the offsets until you are satisfied that the results from the new mixing chamber lens combination.
- 6. Save the new values in a paper channel.**
- 7. If you already have several paper channels set up you can add your new offsets to a given paper channel so that you will have KODAK paper emulsion 1 w/ 8x10" box and 360mm, Kodak paper emulsion 1 w/ 4x5" box and 150mm, ILFORD paper emulsion 1 w/ 8x10" box and 360mm, Ilford Emulsion 1 with 4x5" box and 150mm, etc etc.**

When saving and recalling jobs, the new mixing chamber lens combination will be saved with the job information as a paper channel.

->9: EDIT VC-SCAN CHANNELS

If using the VC-SCAN with the DIGITAL LIGHT for black and white printing, this selection opens up a screen in which the contrast and density characteristics of each VC-SCAN channel. Please refer to the VC-SCAN manual for more detailed information.

->10: EDIT COLOR PRO STYLES

Used to adjust the density and color characteristics for each *COLORPro* style channel. Please refer to the *COLORPro* manual for more information.

->11: EDIT COLOR PRO FILMS

Used to adjust the density and color characteristics for each *COLORPro* film channel. Please refer to the *COLORPro* Manual for more information.

->12: EDIT COLOR PRO CALIBRATION VALUES

Each new *COLORPro* has five factory-issued calibration values. These values are entered into the DIGITAL LIGHT using this option. Please refer to the *COLORPro* Manual for more information.

->13: FILT DENSITY CORRECTION GAINS

This screen allows you to edit what percentage of each main screen filtration value will be fed into density. This feature is used to correct the DIGITAL LIGHT operation to work in *visual* density, rather than *neutral* density.

MAINTENANCE MENU

ACCESS THROUGH ITEM 7 IN THE MAIN MENU.

- 1: UNDO LAST PROBING**
- 2: ERASE ONE JOB**
- 3: ERASE ALL JOBS**
- 4: ERASE ALL EMULSIONS**
- 5: ERASE VC-SCAN CHANNELS**
- 6: ERASE COLOR PRO STYLES & FILMS**
- 7: MASTER RESET**

->1: UNDO LAST PROBING

This selection is used when the Density Probe is switched on accidentally. Selecting this menu item will return the DIGITAL LIGHT density setting to the value before the probe was switched on.

->2: ERASE ONE JOB

To erase a job memory use this selection. Regular deletion of jobs no longer in use will keep the memory clear for any new job setups. The system can remember 250 jobs.

->3: ERASE ALL JOBS

Allows you to erase all of the print jobs stored in the memory. This will clear the memory for a whole set of new jobs. All job data is lost.

->4: ERASE ALL EMULSIONS

This selection erases all Emulsion offsets and selects Emulsion 0 as the current Emulsion.

->5: ERASE VC-SCAN CHANNELS

Clears all data from the VC-SCAN channels.

->6: ERASE COLORPRO STYLE & FILMS

DIGITAL LIGHT – MANUAL 2011.

Clears all data from the *COLORPro* Style and Film channel offsets.

->7: MASTER RESET

Use this to clear the memory and reset all the internal values to their factory settings. You lose all offsets, job memories etc. You must switch off the DIGITAL LIGHT once the memory is cleared, this allows the DIGITAL LIGHT to go through its reset and calibration cycle. Switch off the unit when the display reads "ZBE INC."

WARNING: All stored jobs, offsets, and other DIGITAL LIGHT Color Dichro Head memory will be lost when a master reset is done..

DIAGNOSTICS MENU

ACCESS THROUGH ITEM 8 IN THE MAIN MENU.

- 1: MANUAL CONTROL TEST
- 2: COLOR DICHRO HEAD CYCLE MODE
- 3: PROBE TEST
- 4: RMS VOLTAGE TEST
- 5: ROLL EASEL TEST
- 6: CONTINUOUS READOUT
- 7: AUTO CALIBRATE SENSOR
- 8: STACK CHECK
- 9: MIXING CHAMBER DETECTORS TEST
- 10: VC-SCAN TEST
- 11: COLOR-PRO TEST
- 12: ADC TEST 0-7
- 13: ADC TEST 8-15
- 14: RESET-CYCLE COUNTERS
- 15: CYCLE-MOTORS

->1: MANUAL CONTROL TEST

This diagnostic is used to manually test the basic operations of your DIGITAL LIGHT. In this mode there is no closed-looping. The filters, shutter and lamps are controlled manually. The controls are as follows:

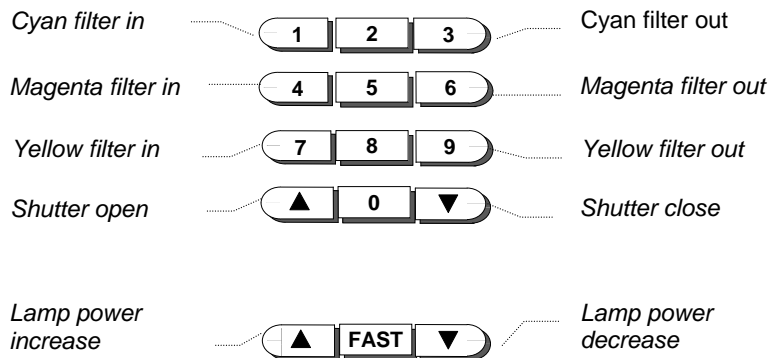

The screen in this diagnostic displays a lot of information. The drawing below details this screen and describes what the information represents:

Raw Filtration CC Values:

These are the values that would be on the main screen if the DIGITAL LIGHT had not yet been calibrated.

Main Screen CC Values:

This is a repeat of the information at the left, but with all offsets applied.

C:-32	M: -17	Y:-23	D: 64	C: 0	M:30	Y:30
3507	3423	3466	VOLTS: 78.4	RMS		

Raw A/D Converter readings:

These are the numbers that the computer is reading directly from it's internal digital voltmeter. These numbers are roughly in millivolts

Lamp Voltage:

Voltage currently applied to the DIGITAL LIGHT lamps. This voltage should read from 7-14 volts when the lamps are off.

->2: COLOR DICHRO HEAD CYCLE MODE

When this mode is selected the DIGITAL LIGHT runs through a preset sequence of filtration values as fast as it can. The lamps stay **on** constantly and when the keypad clicks it has reached perfect color. Use **CANCEL** to exit.

->3: PROBE TEST

This diagnostic is used mainly to test the Density Probe voltages. On the top line the probe density and probe temperature are displayed in millivolts. On the next line the density is displayed in regular CC units and the probe temperature is displayed in degrees Celsius. At the right side of the display the color sensor temperature is displayed in millivolts and below the color sensor temperature is displayed in degrees Celsius. Use **LAMP +/-** turn the lamps **on** and **off**. **CANCEL** will exit this mode.

->4: RMS VOLTAGE TEST

This mode is primarily to check the internal RMS voltage meter that measures the voltage being applied to the lamps. The lamps are run open-loop, through 3 power settings

starting with pre-warm, then a middle value then maximum power as set in the “MAXIMUM LAMPS POWER” preference. The lamps are cycled continuously until **CANCEL** is pressed.

->5: ROLL EASEL TEST

This diagnostic tests the built-in roll easel interface. On the bottom line of the display, the status of the interface’s two output relays and that of the input channel are all shown. The computer cycles the two output relays off and on. As the display for each relay goes from off to on (and from on to off), a slight “click” should be heard from inside the Color Dichro Head. The status of the single input line will not be changed by the computer. Testing this line requires a roll-easel interfaced to the DIGITAL LIGHT.

->6: CONTINUOUS READOUT

This selection toggles the main screen display mode to either display the filtration targets or the actual DCMY values that are currently being read by the sensor. This mode is canceled on every power up.

->7: AUTO CALIBRATE SENSOR

This diagnostic is actually a calibration cycle but should only be performed if there is a problem and the DIGITAL LIGHT is not closed-looping properly. This calibration is also performed whenever a Master Reset is done or the DIGITAL LIGHT memory is cleared electrically. In this mode, the internal sensor is calibrated to the current lamps transport and mixing chamber such that the sensors will read 0 M0 Y0 when the lamps are at 75% power and all filters are completely out. The cycle takes about 10 seconds, and all process and master offsets are cleared. Use only as a last resort.

->8: STACK CHECK

This is a diagnostic used only in factory testing.

->9: MIXING CHAMBER DETECTORS TEST

This tests reads out the voltages from the mixing chamber sensors located on the DIGITAL LIGHT motherboard. Use this test if you are having trouble with the DIGITAL LIGHT recognizing the mixing box being in place instead of the normal mixing box. Contact DURST-PRO-USA if problems occur.

->10: VC-SCAN TEST

This is a diagnostic for the VC-SCAN probe unit. It reads out various voltages from the unit, and allows the user to test the buttons.

->11: COLOR-PRO TEST

This is a basic diagnostic for the COLOR*Pro* probe unit. It reads out various voltages from the unit, and allows tests of the buttons.

->12: ADC TEST 0-7

The DIGITAL LIGHT Color Dichro Head has a total of 16 analog voltage inputs that the computer can read. These voltage meters are wired to all the various sensors in system, including the internal color sensor and lamp voltage measurement circuitry, the Density Probe and other accessories. This diagnostic simply displays the raw values that is sensed on the lower 8 of the 16 inputs.

->13: ADC TEST 8-15

Same as the previous diagnostic, but reads out the upper 8 of the 16 inputs.

->14: RESET-CYCLE COUNTERS

When the cycle motors test is started, the computer keeps a count of how many cycles the filter motors and shutter motor have gone through. Each cycle represents one full traverse of that filter's movement. This menu item resets all counters back to zero.

->15: CYCLE-MOTORS

This is a factory burn-in routine that simply runs all the filter motors and the shutter motor all the way in, then all way out. The screen will keep a count of how many cycles the filter motors and shutter motor have gone through. This will continue forever, until power is turned off.

DIGITAL LIGHT RMS LAMP POWER COLOR ERROR CORRECTION

Introduction

One of the main beneficial features of the DIGITAL LIGHT Color Dichro Head is its ability to operate over a 5 f-stop range of neutral density in its light output. The DIGITAL LIGHT uses a “chopper-stabilizer” circuit to vary the voltage that is applied to its lamps in order to make them dimmer or brighter. As with all incandescent bulbs, the lamps in the DIGITAL LIGHT change their color output spectrum as their drive voltage changes, appearing more “orange” as the voltage decreases.

The DIGITAL LIGHT’s Closed-Loop system will of course attempt to correct the light in the mixing chamber using the dichroic filters to counter the color changes that the Color Sensor “sees” at different lamp powers. Of course, since the color sensor does not “see” color exactly the same way as photo paper, some color discrepancy in the final light output can occur. This color error will show up on prints made at different lamp powers.

The software in the DIGITAL LIGHT Color Dichro Head compensates for these remaining errors by using a “look-up-table,” which contains color corrections for every lamp power level from the DIGITAL LIGHT’s minimum of about 30% up to 100%. When the DIGITAL LIGHT’s lamps are on during operation, the color corrections for the power at which they are currently running are constantly being applied using the dichroic filters. This corrects print color errors in most cases. However, changes in photo paper and processing technology, and differences between types of photo materials and laboratory equipment, can introduce errors beyond the scope of the DIGITAL LIGHT’s built-in correction system.

This release of DIGITAL LIGHT software includes a means by which the darkroom technician can enter corrections for prints made at different lamp powers. When a print is made, and there is a color error that should not be there the technician can simply enter color corrections to make the print good, at the current lamp power. The most common situation where these color problems show up is in making a series of prints at different sizes, using the DIGITAL LIGHT’s Density Probe, or the Sentinel enlarger’s Size-to-Density Correction to adjust the density (and thus, the lamp power). If the prints in such a series do not all match, the darkroom technician now has a means by which to correct this. It is not necessary to make a print at every single power level from 30%-100%, as this would be exceedingly tedious and prone to error.

System Overview

This RMS Lamp Power Color Correction System allows you to enter color corrections for up to 15 “RMS Power Points.” Each “RMS Power Point” is a set of red, green, and blue correction values associated with a specific lamp power level. The color corrections are scaled to paper CC’s (at the print), and each point’s power level is expressed in lamp power percentage—the same value displayed on the DIGITAL LIGHT keyboard during operation if the “Lamp Power Display” is set to “active” in the Preferences menu.

After a Point is entered, this function will calculate linear interpolations between it and any other Points previously entered. In this way, you need only to program a few Points to cover the entire range of lamp power. These Points can be edited at any time, deleted, or new Points added at any time.

The RMS Lamp Power Color Correction System uses a menu-driven user-interface like everything else in the DIGITAL LIGHT’s computer system. It maintains a list of the points that the user has entered, and always lists them in ascending Lamp Power order.

Programming the RMS Lamp Power Color Correction System

At the heart of making this system work is the task of programming the necessary RMS Power Points to correct any color errors you may be experiencing. Generally, a minimum of 5 or six points are necessary to get a good response. More points can be added in the future to achieve even greater accuracy.

In order to program points, we must first get data. This data will come from a series of prints that will be made throughout a range of lamp power levels. There are two ways to do this:

Method One: Prints made at the **same size**, using the lens aperture and DIGITAL LIGHT Density Probe to change the lamp power level for each print to keep all of the prints at the same density

Method Two: Prints made at different sizes, but with the **same lens aperture**, using the DIGITAL LIGHT Density Probe or the Sentinel’s Size-to-Density Correction to keep the prints at the same density.

Method One prints will be easier to judge since they will all be the same size. Method Two is easier to perform if you are using a Sentinel enlarger with Size-to-Density Correction. The accuracy in either case will be best if you have a color densitometer available to read the prints.

Programming the system is a two-stage process: First, we need to make the prints, as described above. Second, we must read the prints and derive the color corrections necessary to make them all match. These two stages are described here,

❶ *Making the Prints:*

Regardless of the method used to make the prints, the DIGITAL LIGHT's Lamp Power Display must be switched to "Active." The lamp power level for each print is as important as the color corrections needed to make it. For Method One, it is easiest to have the Probe With Autocorrection feature Active as well. For Method Two, using a Sentinel 4x5" auto-focus enlarger, activate the Size-to-Density Correction feature.

Method One:

1. Setup your enlarger to make a print at about 10 seconds, at the highest numbered f-stop setting on your lens (aperture closed). Use the Density Probe and change the print size until the print comes out good at a lamp power level between 93% and 96%.
2. Make your first print. Important: Write down the lamp power level that was used.
3. Open the lens one f-stop. Use the Density Probe to correct density.
4. Make the next print and write down the lamp power used to make it. This lamp power will be lower than the previous one.
5. Repeat steps #3 and #4 until you have a total of 5 prints, and a list of 5 power levels. Be sure to mark each print so you can later correlate each print with its power level.

Method Two:

1. Setup your enlarger to make a large print, at a power level between 93% and 96%. Use the lens aperture to get a good print at this power level and size, changing only for this 1st print.
2. Make your first print. Important: Write down the lamp power level that was used.
3. Move down to a smaller print size. One standard size smaller will probably do fine. If you are using a Sentinel Enlarger, the Size-to-Density Correction will change the lamp power for you. If not, use the Density Probe to do so.
4. Make the next print and write down the lamp power used to make it. This lamp power will be lower than the previous one.
5. Repeat steps #3 and #4 until you have a total of 5 prints, and a list of 5 power levels. Be sure to mark each print so you can later correlate each print with its power level.

While making these prints, watch that the exposure time does not change when changing lamp power levels. If it does, end the series, and do not use the print on which the time changed. The last print should be made between 35% and 40%.

② Reading the Prints and Programming the Points:

At this point, you should have a series of about five prints, each made at a different power level. These power levels should range between a high above 90% and a low below 40%. If this range is not covered, you can still program some points to correct color in that range.

- Using your normal quality-control procedures, assess each print's color error. It is best to write down the color corrections you plan to make before entering them into the RMS Power Point list. This makes it easier to trace your steps. *Do not worry about any density errors yet.* If there are density errors, you will find that they will resolve out as the color problems are corrected. Your color error corrections should be print-level corrections, not Color Dichro Head corrections. Errors at the print are about twice to 2.7 times the error at the head. Correct at the *prints*. If you have a densitometer, the numbers it provides are already in the correct scale for use in the RMS Power Point corrections.

<i>Power</i>	<i>R</i>	<i>G</i>	<i>B</i>
94%	+5	1	-1
76%	+2	0	0
57%	0	+2	-3
43%	-5	+3	-6
37%	-12	+11	-19

- After assessing the prints, you should have a list that looks similar to that shown at right. You can see that you do not need to make one color always zero. The system will do this internally.
- Access the RMS Power Point list from the DIGITAL LIGHT's Calibration menu item "14: LAMP POWER COLOR ERROR CORRECTION." You will be presented with a screen like that shown here:

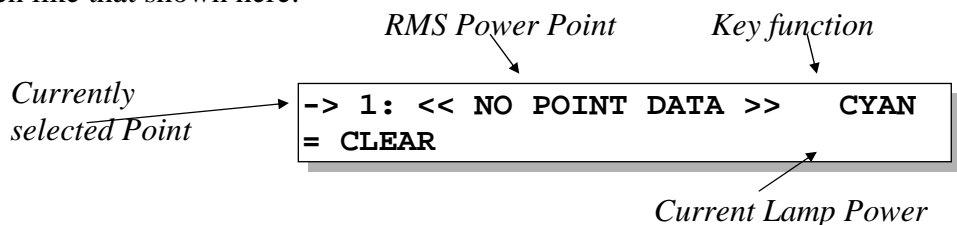

The RMS Lamp Power Color Error Correction Pint List

- To enter the data for a point, select an empty place in the list (number 1 is a good start), and press ENTER. The first number is the power level, expressed as a percentage. The system defaults this value to the current lamp power level. Change this lamp power level to that of the first print on your list by typing in the value and pressing ENTER.
- Type in the cyan/red correction at the "R:" position. **These values will change the light output:** a higher red value here will yield more red light, and thus, a more cyan print. If you use a densitometer, enter, for these color corrections, the value that would need to be added to your densitometer reading to get to the value that you want. If you have no correction for this color, enter zero (0). Press ENTER to advance through the green and blue values, entering them in the same manner. This numeric entry is the same as many of the others in the DIGITAL LIGHT system: The CANCEL key will retreat one value, ENTER advances one value. Pressing ENTER after the last value will accept the point

data into memory.

6. Continue entering all of your Point data. For each new Point, be sure to use the Arrow Keys to move to any empty place in the list. To clear a point, select it using the Arrow Keys, then press CYAN. This will eliminate the information there, which is different than changing the values to Zero.
7. When finished, press CANCEL to exit this screen. You will be warned if there are two Points programmed with the same power level, and placed back into this Point list screen to change one of the two offending points. Once all points are correctly entered, the DIGITAL LIGHT will build a new Look-up-Table using your data.

The DIGITAL LIGHT is now ready for use with your new corrections. You may elect to run another series of prints to check your results, as it may take two or three iterations of this process to get things completely trimmed in. If, after three runs, the series are not coming out correct, try using more points. This can be done either by stepping the lens by half-stop increments (Method One) or by making smaller printsize changes (Method Two).

More Information: An In-Depth look

Behind the Scenes:

As mentioned in the Introduction, the DIGITAL LIGHT uses a “lookup table” to correct for color errors arising from the changing spectral output form the lamps as they are run at different power levels. The RMS Lamp Power Color Correction system lets the user manipulate this lookup table by implementing a separate lookup table that “rides on top” of the original table. This new table is built from the data that is entered into the RMS Power Points.

Up to 15 RMS Power Points to be entered by the user to cover the lamp power range of 30% to 100%. Since this means there are only 15 points to cover 70 power levels, the DIGITAL LIGHT computer has to fill in the spaces in between the points. It does this by “connecting the dots,” the “dots” being the RMS Power Points entered by the user. As an example, consider the list of color errors from the previous page, shown below at left.

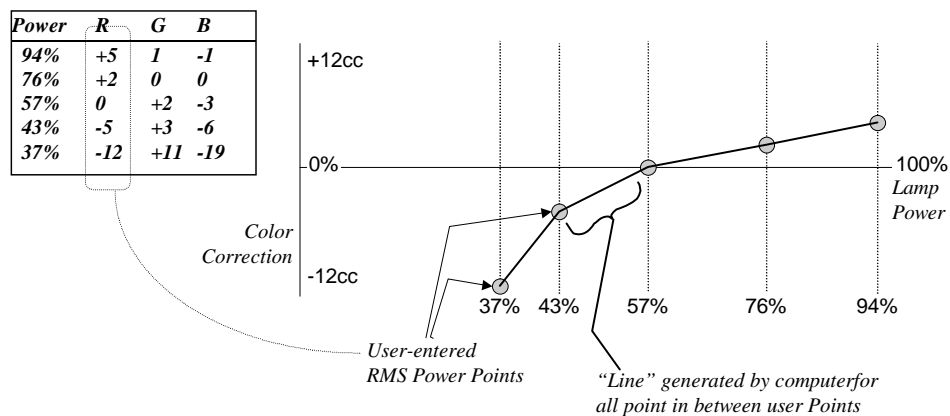

Pitfalls to Avoid:

Since the computer draws in lines between the points, there are a couple of things to be avoided in setting your RMS Power Points. Both of these “pitfalls” will result in the “lines” between your RMS Power Point being very “steep”.

- **Two points with consecutive or very close power levels:**
If two points are very close to each other in power level values, and their color corrections are not close, the line between them will have to travel from one Color Correction value to the next in a few steps of lamp power. This can cause the DIGITAL LIGHT to flicker slightly when its lamp power is within the power range of the steep line.
- **Color Correction values outside the range of -60 to +60:**
The system works within the range of -60cc to +60cc color correction values. You should not need this much correction to correct RMS Lamp Power Color errors.

Other notes on using the RMS Power Points list edit screen:

- When you wish to delete a point, press CYAN when you are pointing to it in the list. This will clear the data. Do not set the point's corrections to zero, since this is not the same as deleting the point.
- Whenever you exit the list edit screen, the computer will re-organize the points in the list in ascending order by lamp power level.
- If you clear all the points in the list (using the CYAN key), the lookup table will also be cleared, yielding the same performance as previous software versions.

MECHANICAL MAINTENANCE & UPGRADING

The DIGITAL LIGHT Color Dichro Head is designed for as little mechanical maintenance as possible. As such, the maintenance required is merely the cleaning of various parts of the machine. Some notes on cleaning follow in this section.

GENERAL CLEANING INFORMATION

The DIGITAL LIGHT Color Dichro Head's black finish is a tough powder-coat texture. Although very rugged, some strong solvents or abrasive cleaners may cause marring of the surface. Therefore, a standard household cleaner, applied with a soft cloth or paper towel, is recommended for general cleaning and dusting.

FILTER TRANSPORT

With normal use, the lamps transport should be cleaned once a month to remove the natural build up of dust. The transport should be removed for cleaning. First, disconnect the power at the source. The dust should be removed using compressed air, which should be done outdoors. Spray the compressed air throughout the lamps compartment, through the fan, around the motors, and on the filter blades that have the colored glass pieces. It is important to clean the glass pieces thoroughly. You may rotate the filter blades by hand for better access to each individual filter blade. After the compressed air, wipe the glass filters with a soft cloth or soft paper towel. If there is a build up dirt on the glass, use a small amount of household glass cleaner or photo lens cleaner. Before re-installing the transport make a general inspection, checking that the lamps look good and properly seated, the motors and wiring look proper. Re-install the transport by aligning the top and bottom into the guide rails and pushing on the finger hole.

LAMPS

Periodically, the enlarging lamps will blow out and require changing. To access the lamps, First, disconnect the power at the source.

Some lamp tips:

When one lamp blows it is strongly recommended to exchange **all** the lamps in the lamp-house. Lamps deteriorate during use affecting their peak color output – they tend to discolor on one side of the small filament, loose power etc. and the reflectors fade over time causing color changes – therefore inserting one new lamp with one or more old lamps may create uneven light or hot spots. Also, lamps have an average life of approx. 50 hours depending on use and when one lamp blows it is more than likely that the next lamp will blow shortly after,

and then the next, and the next and so on. So to avoid the hazards of accessing the lamps on a routine basis and get your work interrupted, change all lamps when the first lamp blows.

Don't mix lamp types. Different manufacturers use different reflector geometry's, which causes the light to mix slightly differently.

Don't touch the glass inner bulb part of the lamp. Oil from your hands will cause uneven heating on the bulb, causing cracking and explosion.

UPGRADING DIGITAL LIGHT COLOR DICHRO HEAD SOFTWARE

When upgrades becomes available each customer will be informed.

DIGITAL LIGHT ACCESSORIES

Serial communications for RS-232 interfaces.

COMPort Pinouts for D-9 and D-25 Connectors

D-25 Pin Numbers		D-9 Pin Numbers	
2	Tx (D-25)	Rx (D-9)	2
3	Rx (D-25)	Tx (D-9)	3
4	Request to Send (RTS)	7	
5	Clear To Send (CTS)	8	
6	Data Set Ready (DSR)	6	
7	GROUND	5	
8	Data Carrier Detect/Ready	1	
20	Data Terminal Ready (DTR)	4	
22	Ring Indicator (RI)	9	

Hardware-defeat connections for interfacing to Starlite, which uses Software Flow Control. These may not be necessary, depending upon the PC software being used.

Starlite Keypad Modular Plug Pinout

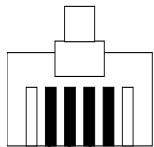

End-View of Modular Plug to be inserted into Starlite Colorhead

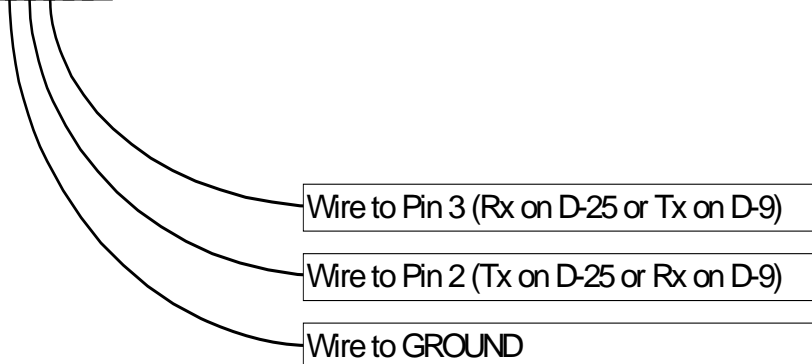

Basic

Commands:

- ^E** Select PC control mode. This stops continuous screen updating. ^E = \$05.
- C** Cyan filtration entry. Send up to 3 digits then <cr>.
- M** Magenta filtration entry. Send up to 3 digits then <cr>.
- Y** Yellow filtration entry. Send up to 3 digits then <cr>.
- T** Exposure time entry. Send up to 4 digits then <cr>. Don't use a period.
- X** Initiate an exposure command.
- l** Lamp **on**.
- d** Lamp **off** (immediate).
- D** Lamp **off** (after reaching color).
- W** Lamp **on** in White Light mode.
- ?** Request status. 3 bytes are returned from DIGITAL LIGHT. "LIY" for lamp **on**, filters in, on color. "DON" is sent for lamp **off**, filters out, not on color. Each byte is independent and has two possible states.

Other Commands:

- L** Toggle lamp **on/off**.
- F** Toggle filtered light/white light.
- P** Request to update display data. (Print data).
- r** Request current filtration targets. (Data packet output).
- s** Input new filtration targets. Send out 27 bytes. (Data packet input).
- @** Job recall. Send up to 5 digits then <cr>. Recalls internal job.
- !** Job store. Send up to 5 digits then <cr>. Store new job.
- |** Demo mode, cycles through internal jobs.
- a** Go into menu.
- M** Go into menu.
- + -** Move up and down through menus.
- t** Rest automatic lamp turn-off timer.

Data packet format for 's' and 'r' operations: 27 bytes total.

For a setup of D64,C0,M50,Y60, Time 5.0 seconds, Emulsion 2, Color mode.
The data packet would be:

+000,+050,+060,+064,005020<cr>

The values are coded as follows:

cyan mag yel dens time end of packet character
 | | | | / || \ |
 +000,+050,+060,+064,005002<cr>
 ||
 ||
 display mode emulsion number























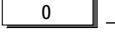
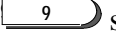

If you want the DIGITAL LIGHT to go to this filtration pack you would send the following bytes:

s+000,+050,+060,+064,005020<cr>

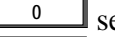
The first 's' character tells the DIGITAL LIGHT the data is following.

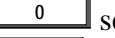
If you sent a 'r' character thereafter the same data packet would come back verifying the data was received.

If you are using a PC instead of the DIGITAL LIGHT keypad, it is helpful to know the character codes for the various keys on the keypad.

-  sends a 'W' character.
-  sends a 'L' character.
-  sends a 'X' character.
-  sends a 'C' character.
-  sends a 'M' character.
-  sends a 'Y' character.
-  sends a 'V' character.
-  sends a 'N' character.
-  sends a 'T' character.
-  sends a 'O' character.
-  sends a '!' character.
-  sends a '@' character.
-  sends a 'P' character.
-  sends a 'S' character.
-  sends a 'A' character.
-  sends a <cr> character (ASCII 13).
-  sends a <esc> character (ASCII 27).
-  -  sends the matching digit character.
-  next to  sends a '+' character.
-  next to  sends a '-' character.
-  next to  sends a 'U' character.
-  next to  sends a 'D' character.

If you are trying to emulate the DIGITAL LIGHT keypad display it may be useful to know the LCD control codes.

[^K] , [N1] , [N2] Position cursor at Y,X; N1=vert+32 N2=horiz+32
[^N] , [N1] Cursor type N1 = 1=none 2=underline 3=blinking
[^I] Clear LCD display
[^E] Key query send current key ('*' = no key).
[^G] Speaker beep
[^F] Speaker click
[^R] Speaker tick
[^V] Backlighting on
[^W] Backlighting off

Other control characters are ignored. Non-control characters are displayed on LCD display.

The ZBE DENSITY PROBE FOR DIGITAL LIGHT

INTRODUCTION

The DIGITAL LIGHT Color Dichro Head offers many features designed to make your darkroom work easier. One of the most useful of these is the DIGITAL LIGHT's ability to accurately change its light output intensity, or light density. This allows the DIGITAL LIGHT to automatically adjust the density of a print being made, not by only adjusting the exposure time as with conventional Color Dichro Heads, but also by changing the density of its light output. This feature is realized to its full potential in the DIGITAL LIGHT Color Dichro Head.

The Density Probe utilizes this feature of the DIGITAL LIGHT by letting the Color Dichro Head "see" the amount of light at the baseboard of your enlarger. This allows the DIGITAL LIGHT to automatically keep the light at the print consistent with the user's density value, or simply to give the user an accurate densitometer readout from under the lens.

HOW DENSITY WORKS

AN OVERVIEW OF DENSITY IN A PHOTOGRAPHIC PRINTING SETUP

Consider a basic enlarger setup for making prints from negative film. The light from the Color Dichro Head must pass through the negative and the lens before it gets to the photo paper. This means that both the negative and lens have an effect on the amount of light reaching the print.

Since we cannot change the density of the negative being printed, the things that can change a print's density are:

Amount of light from the Color Dichro Head: Of course, if you increase the light from the Color Dichro Head, you will get more light at the baseboard.

Exposure time: The more time light falls on the photo paper, the more exposed that paper becomes. It can be said that the paper “adds up” all the light that hits it as time passes, and that sum is the density of the print.

Aperture of the lens: The lens can vary the amount of light that passes through it using the aperture setting. A smaller aperture (higher f-stop number) will allow less light to reach the baseboard than would a larger aperture. Thus the lens has control over the light density at the baseboard.

The magnification of the enlarger setup: A larger baseboard image spreads the available light over a larger area, decreasing the amount of light per square inch (or “density”) at the image area. As a result, the magnification of the enlargement being made also has control over the light density at the baseboard.

A conventional Color Dichro Head is not able to change its light output (only the filtration), and for a normal enlargement, the magnification is not a viable way to achieve density changes. As a result, the operator would have to adjust the lens aperture or exposure time to affect density changes on the print.

But what if the Color Dichro Head had the ability to do two things: to see the amount of light falling on the baseboard, and be able to vary the amount of light it emits?

If the Color Dichro Head was told how much light at the baseboard makes a good print, it would be able to maintain that baseboard density, by varying its light output and reading the resulting amount of light at the baseboard. Changes in lens aperture (or the lens itself) and changes in magnification could easily be compensated for.

The DIGITAL LIGHT Color Dichro Head is able to vary the amount of light it emits, over a range of about 5 f-stops. The Density Probe, when used with the DIGITAL LIGHT Color Dichro Head, allows the Color Dichro Head to read the amount of light directly from the baseboard. This Density Probe will thus allow print size and lens aperture changes, while providing a way for the user to easily maintain a constant print density.

THE ZBE DENSITY PROBE

The Density Probe is a precision electronic light measuring device designed for use with the DIGITAL LIGHT Color Dichro Head. It becomes the “eyes” of the DIGITAL LIGHT when determining the amount of light currently falling on the baseboard. Using the Density Probe, you can freely change the aperture setting of the lens (or the lens itself), or even change the magnification. After the change, you simply probe the light at the baseboard, and the DIGITAL LIGHT will correct the light back to the original density measured at the baseboard.

GENERAL NOTES ABOUT USING THE DENSITY PROBE

Whenever you use the D-Probe, be sure to hold the probe unit as flat against the baseboard or easel surface as possible. Tilting the D-Probe will cause inaccurate readings.

When taking a probe reading, place the probe as close to the lens center as possible. When activating the D-Probe button, be sure not to obstruct the probe’s “eye” with your hand. Also, once you have started the probing cycle, it is best to leave the probe in place, removing your hand from it until the cycle is complete.

INSTALLATION

The Density Probe connects to the DIGITAL LIGHT Color Dichro Head at the top telephone-type jack on the left side of the Color Dichro Head’s enclosure. The probe’s cable can then be routed to allow the probe itself to rest on and around the baseboard area of the enlarger.

Before the Density Probe can be used in making prints, it must first be calibrated to your standard negative (Shirley) setup. This is simply a process by which you tell the DIGITAL LIGHT what amount of light at the baseboard corresponds to a given density value at the keypad screen.

SETTING THE DIGITAL LIGHT PREFERENCES FOR THE DENSITY PROBE

The following preferences in the DIGITAL LIGHT Preferences menu pertain directly to the operation of the Density Probe. Please review these settings in your DIGITAL LIGHT in order to know what to expect from the probe.

PROBING LIGHT

FILTERED / WHITE

If set to “FILTERED”, the DIGITAL LIGHT will leave the current color filter setting in place when a probing cycle is started. This way, any density contained in the color balance of the current filtration will be “seen” by the D-Probe’s “eye”, which reads white light.

If the probing light is set to “WHITE”, any color filtration in the current filtration setting will be removed before the D-Probe starts reading the light at the baseboard. This setting, which is the factory default, will allow the D-Probe to track the neutral density of the output. This means that the system’s keypad density value will track with most video analyzers, even when using the D-Probe.

PROBE WITH AUTOCORRECTION

ACTIVE / INACTIVE

When set to “ACTIVE”, the DIGITAL LIGHT will change it’s light output to make the D-Probe reading match the light level that corresponds to the current keypad density value, in accordance to the level at which the D-Probe was calibrated during the Calibrate Master Color Balance procedure (see Advanced Operations). This is the factory default setting. Using the D-Probe in this mode will allow you to always be sure that the same amount of light is falling on the baseboard when a particular density value is shown on the keypad screen, regardless of lens, aperture, or magnification changes.

When set to “INACTIVE”, the DIGITAL LIGHT will simply provide a passive readout of the light level it reads at the baseboard. When the light is at the same level as that used to print the Shirley, the D-Probe’s reading will display the keypad density value that was used when the Shirley was printed (when the D-Probe was calibrated).

The actual procedure for using the D-Probe depends on the setting of the Autocorrection preference. A description of each method can be found in the General Use section of this manual.

CALIBRATING THE DENSITY PROBE IN / FOR COLOR MODE:

The Density Probe is calibrated at the same time that the DIGITAL LIGHT Color Dichro Head's Master Color Balance is calibrated. This is the case whether or not a video analyzer is used with the DIGITAL LIGHT. This procedure is given for both cases in the user's manual. A generalized procedure follows:

Summary:

1. Setup your enlarger for printing your Shirley negative.
2. Enter an exposure time using **TIME** (5 seconds).
3. Select Emulsion channel 0 (zero) from the main menu.
4. Enter a filtration of C0 M40 Y40.
5. Enter a Density of 0.
6. Use the most popular paper stock that will be represented by Emulsion channel 0.
7. Press **EXPOSE** to make exposure.
8. Adjust Magenta, Yellow and Density to achieve a perfect print.
9. Make test prints until you have a perfect print.
10. Go into Calibration menu.
11. Select Calibrate Master Color Balance from menu.
12. Enter the video values for D,C,M, and Y. (64 0 30 30).
13. Press **ENTER** when asked to Calibrate Density Probe.
14. Place empty carrier in enlarger, turn room lights off.
15. Place probe directly under lens on baseboard.
16. Wait 6 seconds, then press **ENTER** to take probe reading.

Your DIGITAL LIGHT can be aligned so your standard setup negative prints perfectly at any set of DCMY values you choose to use. In other words, the filtration at which your Shirley prints perfectly on the DIGITAL LIGHT may be assigned any set of D,C,M, and Y color correction values, according to personal choice or in order to conform to the standard filtration of your lab or video analyzer. Many labs like their setup negative to print at D64 C0

M30 Y30, another popular setting is D64 C0 M16 Y16. You may find it more convenient to use a round number for the density such as 0 or 100; it's your choice.

1. Setup your enlarger for printing a Shirley negative. Use your normal lens, carrier, easel, etc.
2. Enter an exposure time, say 5 seconds.
3. Select Emulsion 0 (zero) in the main menu. This channel will represent the type of photo paper on which you are about to test-print your Shirley.
4. Enter a filtration pack to start with. A setting of C:0 M:40 Y:40 is a good starting place.
5. Enter a Density of 0 to start with.
6. Turn off the darkroom lights and place the paper on the easel/baseboard. Use your most popular paper stock, that which is to be represented by paper Emulsion 0. When handling paper, you may turn off the keypad lighting by pressing **DISPLAY**.
7. Make the exposure by pressing **EXPOSE**.
8. Adjust the Density, Magenta, and Yellow values and make the next test print.
9. Continue making adjustments and test prints until you achieve a perfect print.
10. Once you have made a perfect print, the next step is to make the display read the correct DCMY values (e.g. D64 C0 M30 Y30) for printing a Shirley in your lab. Any values may be used. To do this go into the main menu and then into the Calibration menu.
11. Select item 2, "CALIBRATE MASTER COLOR BALANCE" from this menu and press **ENTER**.
12. You will see the current filtration values displayed, with the cursor flashing on the density value. You may now replace these values with any numbers you wish. To advance the cursor to the next color, press **ENTER**. If the values are Density 64, Cyan 0, Magenta 30, and Yellow 30, enter: "64 ENTER, 0 ENTER 30 ENTER 30 ENTER." If the density number is negative and should be positive then press **LAMP +/-**, which will toggle the sign of the number. After the entry for Yellow, pressing **ENTER** will complete the entry of DCMY values. If you enter an incorrect number, press **CANCEL** to regress to the previous value.
13. Once all the filtration values are entered, you will be asked if you would like to calibrate the Density Probe. To calibrate the Density Probe, press **ENTER** now. The lamps will turn **on**.

14. You will be asked to take a probe reading. Remove the test negative from the carrier and then put the empty carrier back into the enlarger.
15. Place the Density Probe on the baseboard, centered directly under the lens.
16. Wait for about 6 seconds to let the probe stabilize, then press **ENTER** to lock in the probe reading.

When the lamp goes out, the Master Color Balance is now set to print a perfect Shirley at the DCMY values entered in step 15.

GENERAL USE OF THE DENSITY PROBE

As mentioned earlier, the way in which the Density Probe is used differs depending upon the setting of the Autocorrection preference in the Preferences menu. The probing methods in each case are described below.

PROBE WITH AUTOCORRECTION SET TO ACTIVE

1. Load your negative and compose and focus the image as desired.
2. Enter the color filtration values and density value at which you are going to print this negative into the keypad. These values may be entered directly from a video analyzer.
3. Remove the negative from the carrier. This allows the light at which the negative will be printed to be visible at the baseboard.
4. Place the D-Probe in the center of the baseboard area, directly under the lens.
5. Press the button on the D-Probe.

The Color Dichro Head lamps will turn **on**, then the light level will change until the amount falling on the D-Probe matches the D-Probe's expectation for the current keypad density value. When the system is satisfied it has a stable reading, the lamps will turn **off** automatically, completing the probing cycle.

PROBE WITH AUTOCORRECTION SET TO INACTIVE

1. Load your negative and compose and focus the image as desired.
2. Enter the color filtration values and density value at which you are going to print this negative into the keypad. These values may be from a video analyzer.
3. Remove the negative from the carrier. This allows the light at which the negative will be printed to be visible at the baseboard.
4. Place the D-Probe in the center of the baseboard are, directly under the lens.

5. Press the button on the D-Probe. The Color Dichro Head lamps will turn **on**, and the keypad display will read “PROBING...” On the keypad, a density value from the probe will be displayed. At this point, the D-Probe is simply reporting what it “sees.” Make any adjustments to lens aperture needed to achieve the density number you want. (Note that this density number is independent of the density value, which represents the light emitted from the head).

When finished, press the button on the D-Probe again to terminate the probing cycle.

USING THE DENSITY PROBE FOR FLESH-TONE PRINTING IN COLOR MODE



The Density Probe used with the DIGITAL LIGHT Color Dichro Head is usable for matching the density of flesh-tones on different images. Although this method will not match the color balance of the images, it will work to match the density. The generalized method is to make a perfect print from a standard (Shirley) negative, then calibrate the Density Probe while reading a flesh-tone area of the image. Thereafter, new negative images' flesh-tones can be matched simply by probing the appropriate area.

SETTING UP THE DIGITAL LIGHT FOR DENSITY PROBE MATCHING OF FLESH-TONES

Choose a medium or large print size. A minimum of 8x10 is recommended for flesh-tone matching (depending on the size of the flesh area in the negative). This is due to the fact that the aperture on the D-Probe itself must completely lie within any flesh-tone area in the image; a larger print size tends to allow a given patch of flesh tone in the image to completely cover the D-Probe's aperture.

1. Make a perfect print from the negative at this size. Do as many prints as necessary to achieve a print that is good in both color and density. Even though the Density Probe will not be able to match this color, the color balance will affect the density reading.
2. Once the perfect print is made, begin re-calibrating the Master Color Balance by selecting the “CALIBRATE MASTER COLOR BALANCE” option from the Calibration menu.
3. Enter the filtration values to be associated with the perfect standard print made in step 2. Keep in mind that the Density number *will be the same for all future prints*. This is due to the fact that the Density Probe will always be looking for the same level of light in the flesh-tones of future negatives, regardless of each negative's overall density.

Recommended filtration values for most setups are D:64 C:0 M:30 Y:30.

4. After entering these values, the keypad will prompt, “WOULD YOU LIKE TO CALIBRATE THE DENSITY PROBE NOW. PRESS ENTER IF YES.” Press  to confirm this. At this point turn the room lights *off*.
5. The keypad will then prompt “PLEASE REMOVE NEGATIVE FROM CARRIER. REPLACE CARRIER TAKE PROBE READING.” When setting up for flesh-tone printing, **do not remove the negative from the enlarger!** Position the D-Probe on the image being projected, in a flesh-tone area that is free of excessive highlights, shadows, jewelry, or anything else. Look closely at the Density Probe’s aperture to be sure that it is *entirely* within the flesh-tone area.
6. Press  to take the reading.

After the probe reads the current amount of light representing the flesh-tone, the keypad display will read “PROBE CALIBRATION COMPLETE,” after which the display will revert to the normal main screen. The filtration values displayed will reflect the values that were entered into the Master Color Balance calibration.

The setup for printing using the D-Probe to match flesh-tones is now complete. The next section outlines the use of this system in day-to-day printing.

USING THE DENSITY PROBE TO MAKE PRINTS USING FLESH-TONE MATCHING:

1. Load the negative to be printed into the carrier. Compose and focus the print at a medium-to-large printsize. Set the lens to the desired aperture.
2. Enter a starting filtration pack into the DIGITAL LIGHT. Remember that **the Density value will be the same for all negatives** when using the D-Probe for matching flesh-tones. If you calibrated the standard negative to a Density value of 64 (given as an example in the previous section), always start printing at D:64, regardless of the thickness of the new negative.
3. Position the Density Probe on the image so that it’s aperture lies *completely* within a flesh-tone area. Press the button on the D-Probe, making sure that nothing (fingers, etc.) is blocking the probe’s aperture.
4. The DIGITAL LIGHT will take the probe reading by turning it’s lamps **on**, then adjusting it’s light output so that the amount of light reaching the probe will be the same as it was when the probe was calibrated.
5. Once the probe is finished, the lamps will turn **off**. You are now ready to make a print.
6. Turn off the room lights, load the paper, and make the print by pressing .

Please note that this method has limitations. As mentioned earlier, the print size will be limited to the smallest size that will allow the D-Probe's aperture to lie completely within a flesh-tone area of the image. Also, since this setup is done explicitly for flesh-tones, printing other subjects will be a little tricky. For instance, when printing a landscape image (with no flesh-tone areas), an area comparable in density, if not color, will need to be used for the probing. This method of printing also excludes using any kind of video analyzer with the system.

USING THE DENSITY PROBE IN BLACK AND WHITE PRINTING MODE

The use of the Density Probe is very similar in Black and White printing mode as for Color. A very important thing to note however, concerns the use of safe lights. **Whenever you probe be sure all safe lights are OFF.** The D-Probe will read the safe light as additional density at the baseboard, causing inaccurate operation.

CALIBRATING THE DENSITY PROBE IN BLACK AND WHITE MODE

The DIGITAL LIGHT Color Dichro Head has separate facilities for aligning the Density Probe in Color mode or Black and White mode. This is necessary since in Color mode the Emulsions, Process offsets, etc., can have density offset values that effect the Density Probe reading, whereas in Black and White operation, the Emulsions and Process offsets are disabled. Consequently there is a separate, simple procedure to align the Density Probe for Black and White printing. This procedure differs from that in the Color printing mode.

Before performing this procedure, make sure that the Density Probe is properly connected.

1. First select Black and White printing mode in the main menu.
2. Select a "regular" black-and-white negative, one that represents an average negative printed in your lab.
3. Make a good print from this negative. See the section in the user's manual How To Make A Black And White Print By Testing.
4. From the main menu, select the Calibration menu and then select the "CALIBRATE B&W PROBE DENSITY" option.
5. You will be instructed to remove the negative from the carrier and take a probe reading. At this point you should remove the negative from the carrier.
6. Place the Density Probe on the baseboard, centered directly under the lens. Be sure the room lights and any safelights are *off*. Wait 4 seconds for the probe to stabilize and then press .

The Density Probe Black-and-White calibration procedure is now complete. The Density number now displayed will represent a good probe reading for this negative. If this negative was selected properly, most other black-and-white negatives will print near this density value. The alignment set up here has no effect on any of the Color printing settings.

GENERAL USE IN BLACK-AND-WHITE MODE

The use of the Density Probe in Black-and-White mode is the same as in Color printing mode. Generally, you set your print up as desired, place the D-Probe under the lens, then press the button on the probe. If Auto correction is on, simply wait for Color Dichro head to adjust the density, and the lamps will automatically shut **off**, ready for printing. If Auto correction is off, adjust the lens aperture until the desired density readout number is displayed, then press the probe button once again to terminate the cycle. A more detailed description of the procedure by which a black-and-white print is made, appears in the user's manual.

CALIBRATING THE DENSITY PROBE FOR FLESH-TONE PRINTING IN BLACK AND WHITE MODE

To align the Density Probe for probing flesh tones in Black and White mode follow these steps:

1. If the DIGITAL LIGHT is not in Black and White mode, select Black and White mode from the main menu.
2. Using a black and white negative that is representative of the type of negatives you normally print, make a good print, preferably close to grade 2.0.
3. Once you have a good print, go into the main menu, then the Calibration menu and select "CALIBRATE B&W PROBE DENSITY." Don't remove the negative or change the lens aperture etc. at this point: you must do the calibration procedure with everything the same as when you made the good test print.
4. You will be asked to remove the negative, but do not. Place the Density Probe on the baseboard directly under a good patch of flesh tone that is not too far from the center of the image. Be sure that the flesh tone completely covers the reading aperture on the Density Probe. The room lights and safelights should be *off*. Wait 4 seconds and then press **ENTER**. That completes the alignment procedure for flesh tone probing. Write down the density number displayed on the main screen now: it is your new target flesh tone Density number 7.

BLACK AND WHITE PRINTING BY PROBING FLESH TONES, OR ANY OTHER STANDARDIZED TONE.

The Density Probe can be used for “density analyzing” when in Black and White mode. Instead of using the Density Probe to simply maintain the Density calibration (probing with no negative), you can use the Density Probe for simple density analyzing of tones. In this way you can select the contrast grade first, then probe a tone to set the density automatically.

The following is an outline of how printing is done when probing flesh tones:

1. Take a new negative and place it in the enlarger to make a print.
2. Set the contrast grade to 2.0, or whatever grade you wish to use.
3. Focus and compose the image as usual.
4. Enter your tone target density value. This is the value to which the Density Probe was calibrated initially. (See the previous section: Aligning the Density Probe for Flesh-tone Printing in Black and White)
5. Take a probe reading by positioning the Density Probe on the baseboard under the chosen tone. Click the probe once to start probing, then wait a few seconds for the probing to finish. After the lamps go **off** you are ready to make the print.

END. GOOD LUCK.